

RAPID BAROSTAT BAG PUMP

USER MANUAL

REF P1 – RBB – 1



 Mui Scientific

 Mui Scientific
145 Traders Blvd. E., Unit #34
Mississauga, Ontario
Canada L4Z 3L3
Tel: (905) 890-5525
Toll Free: (800) 303-6611
Fax: (905) 890-3523
Email: mail@muiscientific.com
Website: www.muiscientific.com

EC REP

Authorizes Representative in EU: Advena Ltd:
Tower Business Centre, 2nd Floor, Tower Street, Swatar, BKR
4013, Malta

CH REP

Authorizes Representative in Switzerland:
TAS SAT AG
Chamerstrasse 172, 6300 Zug
Switzerland

UKRP

Authorizes Representative in UK: Advena Ltd.:
Pure Offices, Plato Close, Tachbrook Park, Warwick, CV34 6WE,
UK



**UK
CA**
AB 8532

CE
2862

Manual P5-K-104,

Date: March 2, 2026 eRevision 3

Electronic copy of User Manual is available on Mui Scientific website: www.muiscientific.com

CAUTION: Federal Law (U.S.) restricts the sale of this device to, or by the order of physician.

THIS PAGE IS INTENTIONALLY LEFT BLANK.

TABLE OF CONTENTS

Before Using the Pump	1
Introduction	2
Safety Information	5
Operating Requirements	5
Electrical Requirements	7
General Specifications	7
Wireless Interference Prevention	7
Applicable Standards and Warning Symbols	8
Warning Statements and Warning Symbols	9
Getting Started	10
RBB Pump Components	11
Using the Power Adaptor	15
Remote Control Battery	16
Powering On the RBB Pump	17
Pairing the RBB Remote Control	19
First Time Setup	21
Setting Up Password Protection	21
Default Pump Settings	23
Uploading Hospital Logo	25
Setting the Time and Date	27
Changing Keyboard Language	28
Operating Instructions	29
Patient Information	30
Adding a New Patient Profile	30
Editing Patient Information	31
Before Performing a Test	32
Connecting the RBB Catheter	32
Toggling the Disable Button	32
Performing an RBB Test	34
Starting a New Test	34
Performing a Capacity Test	35
Performing a Sensation Test	39
Navigating a Test Report	42
Viewing a Test Report	42
Hiding Sensation Cycles	44
Changing the Compliance Value	46
Editing Fields	48
Exporting Files	49
Exporting a Test Report to a USB	49
Exporting a Test Report to a Computer	51
Exporting Multiple Test Reports	53
Export Multiple Patients' Test Reports	54
Taking Screenshots	55
Erasing Data and Restoring	57
Service and Maintenance	59
Care and Maintenance	60
Pump Calibration	61
Volume Verification	63
Resetting Password	67
Updating Software	68
Troubleshooting	70
Replacement Parts	74
Appendices	75

THIS PAGE IS INTENTIONALLY LEFT BLANK.

RAPID BAROSTAT BAG PUMP

BEFORE USING THE PUMP

 Mui Scientific



READ ENTIRE MANUAL
BEFORE OPERATING THIS PUMP

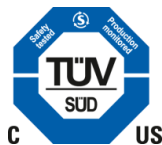

Basic UDI-DI: 0678467RBBGB

INTRODUCTION

The Rapid Barostat Bag (RBB) Pump is a portable, bedside medical device used for evaluating Rectal Motor and Sensory Function. It provides accurate and consistent readings of a patient's rectal capacity, pressure, compliance, and sensation by performing the RBB Test and categorizing patients as having hypo-/normal/hyper-sensitivity based on established percentages.

The RBB Test is a simple two-step rectal barostat procedure (streamlined by Dr. Mark Fox of the University of Zurich) to provide accurate readings of a patient's rectal motor and sensory functions within 10 minutes. The RBB Tests consist of the Capacity Test followed by the Sensation Test. The RBB Pump and Catheter are used together for the inflation of a Barostat Bag to measure Rectal Capacity, Pressure, Compliance and Sensitivity. These findings, in conjunction with normal values established by Dr. Fox can aid in the diagnosis of anorectal disorders, such as fecal incontinence and constipation, as well as aid in surgical pre-screening, biofeedback training, and determining rectal sensitivity of Inflammatory Bowel Disease and Irritable Bowel Syndrome patients.

The RBB Pump uses a battery-operated air compressor, designed to inflate a Barostat Bag at the default rate of **120 mL/min**. The pump is operated through a touch screen, which actively displays the data collected during an RBB Test. At the end of the test, a report is generated by the pump, which can then be exported to an external USB Mass Storage Device. Raw data collected during the test can also be exported for research purposes.

The RBB Pump includes a Bluetooth handheld remote control. During the Sensation Test, patients are requested to identify 3 different sensitivity stages: **Sensation**, **Urge** and **Discomfort**. Using the remote control, patients can provide a direct input to the pump, reducing data latency. Operators of the pump can also provide these inputs directly into the pump for the patients, if the patients are unable to do so, or if the remote control fails to work.

In an emergency, the pump utilizes a Disable Button that immediately deactivates all internal components inside the pump. A valve is opened internally to allow all air from the Barostat Bag to escape, preventing any potential harm to the patient.

*M. Sauter, H. Heinrich, M. Fox, B. Misselwitz, M. Halama, W. Schwizer, M. Fried, H. Fruefauf. (2014). Validation of High-Resolution Anorectal Manometry and Rapid Barostat Bag measurements of rectal function. In M. Simren, G. Mawe, J. Galligan (Eds.). *Neurogastroenterology & Motility* (vol. 26, pp. 685-695)

INTRODUCTION

a) Intended Use

The RBB Pump and Catheter are used together for the inflation of a barostat balloon to measure rectal capacity, as well as rectal volume at points of sensation, urge, and discomfort, to determine hypersensitivity, hyposensitivity, or normal rectal sensations. These determinations aid in the diagnosis of anorectal disorders, such as fecal incontinence and constipation.

The RBB Pump should be used in a medical setting by medical personnel who have received professional training in gastrointestinal manometry.

The detailed instructions contained within this manual is sufficient for guidance of the usage of this equipment; no further training from the manufacturer is required.

b) Indication for Use

Use of the RBB Pump together with the RBB Catheter is indicated when there is a need or suspicion of an anorectal disorder or for evaluating other Rectal Motor Sensory Function.

c) Contraindication for Use

The presence of any stenosis, structural deformity or disease within the rectum, that results in an unacceptably increased risk of distention, perforation, or any other adverse consequence arising from use of this assembly.

d) Warnings

Read through entire IFU to reduce any possible risks from misuse.

These devices are supplied non-sterile.

Proper aseptic technique and universal barrier precautions (UBP) must apply.

Follow RBB Catheter IFU for correct catheter placement.

The RBB Catheters are designed for single-use only. Attempts to reprocess, resterilize, and/or re-use may lead to failure of the device and/or cross-contamination.

Post-procedure RBB catheters are contaminated with body fluid. Immediately dispose of device to prevent re-use.

Read through entire manual to reduce any possible risks from misuse.

INTRODUCTION

Labels on outer surface of RBB pump may fade from cleaning materials. Follow instructions in manual.

The RBB Pump must be used in a hospital setting and should be operated by a qualified medical professional trained in gastrointestinal manometry. Placing the RBB pump or the charging dock on a wet surface may cause short circuiting of RBB system or short circuiting of lithium batteries.

Spilling water on or in the pump or charging dock may lead to electric shock to the operator and/or patient, as well as electrical damage to facility wiring.

Refer to further information under section “Safety Information” for more specific details regarding operating, electrical, and Bluetooth requirements to ensure safe and optimal use.

Refer to further warnings under section “Before Performing a Test” regarding software.

Measuring functions of inflation/deflation rates, volume, and pressure have an accuracy of 5%.

Follow instructions under section “Volume Verification” to ensure optimal performance of the volume and pressure sensors. Volume verification should have an accuracy of 5%.

Refer to the RBB Pump’s Operating Manual for more specific details regarding operating and electrical requirements.

The RBB pump and catheter must not be altered or modified in any way. Mui Scientific is not liable for personal injury and damage to property if original Mui Scientific parts are not being used. Instructions should always be followed as stipulated in the RBB Pump’s Operating Manual.

The RBB Pump has a prescribed lifetime of 6 years.

The RBB Catheter has a prescribed lifetime and shelf life of 2 years.

Dispose of the device safely, in accordance with the local policies where this device shall be used.

SAFETY INFORMATION

The user and/or patient should report any serious incident that has occurred in relation to this device to the manufacturer and the competent authority of the Member State in which the user and/or patient is established.

e) Target Populations

There are no specific intended patient populations.

The use for specific patients is at the discretion of the medical personnel who have received professional training in gastrointestinal manometry.

f) Clinical Benefit

Rapid Barostat Bag Pump is used together with Rapid Barostat Bag Catheter for the inflation of a Barostat Bag to measure Rectal Capacity, Pressure, Compliance and Sensitivity. These findings can aid in the diagnosis of anorectal disorders, such as fecal incontinence and constipation, as well as aid in surgical pre-screening, and determining rectal sensitivity of Inflammatory Bowel Disease and Irritable Bowel Syndrome patients.

Operating Requirements:

- Read all of the information in the user manual before operating the RBB Pump.
- Only perform a test in the presence of authorized medical personnel.
- Performing a Sensation Test requires input from the patient. Do not use this device on infants or patients who cannot communicate their sensation.
- Operate the device only as intended. Do not use the device for any other purposes.
- Only use the RBB Catheter with the RBB Pump.
- Do not operate the device in the presence of flammable or anaesthetic gas.
- Do not continue to use the device and if the volume and/or pressure readings are deemed inaccurate, contact Mui Scientific for assistance.
- The summary findings and data analysis from the RBB Pump should not be interpreted as a final diagnosis for the patient.
- Ensure the device is cleaned properly before every patient use to ensure no cross-contamination (refer to pg. 54 for cleaning instructions).

- To avoid interference with other wireless devices, follow the recommended separation distance when operating the device (refer to Appendix D, pg. 69).
- Do not disassemble the RBB Pump under any circumstances. Contact Mui Scientific for any technical support.
- RBB Pump should only be used by trained operators and Mui Scientific is not responsible about the consequences initiated by untrained personnel.

DISCLAIMER:

Depending on jurisdiction, the pump operator may be responsible for the prevention of unauthorized access and protection of patient data. If this requirement applies, it is recommended that the pump operator delete patient data from the pump prior to sending it for servicing. In such a case, it is the responsibility of the pump operator to back up any patient data.

Mui Scientific is not responsible for maintaining data integrity during pump servicing, and will not copy, back up, or intentionally manipulate any patient data that is stored on RBB Pumps that are received for servicing.

SAFETY INFORMATION

Electrical Requirements:

Input: **100 – 240 VAC, 50/60 Hz, 1.0 – 0.5 A**

Output: **5 V $\overline{\text{---}}$ 5.0 A, 25 W MAX.**

North American Type A Power Cord Included

General Specifications:

Overall Pump Dimensions (including charging station):

Height: **28 cm (10 $\frac{3}{4}$ "**)

Width: **27 cm (10 $\frac{3}{4}$ "**)

Depth: **14 cm (5 $\frac{1}{2}$ "**)

Weight: **2.27 kg (5 lbs)**

Operating Environment Ratings:

10 – 40°C; 30 – 75 % RH non-condensing; 80 – 106 kPa

Wireless Interference Prevention:

The RBB Pump uses Bluetooth 4.1 Technology to communicate with its handheld remote control device. To prevent the pump or its remote control from wirelessly interfering with other wireless devices, both devices must operate within the recommended separation distance requirements specified in Appendix D (pg. 59).

The RBB Pump and remote control both use the same Bluetooth module that emits a maximum RF power of **7.5 dBm (5.6 mW)** at **2.4 GHz** during active operation, and have an effective communication distance within **6 m** of each other. Using Appendix D for comparison, the pump and remote control are recommended to have a separation distance of **0.24 m** from other wireless devices during active operation.

SAFETY INFORMATION

Applicable Standards:

Standard/Document Name	Description
EU MDR 2017/745	Regulation (EU) 2017/745 of the European Parliament and of the Council of 5 April 2017 on medical devices,
ISO 20417:2026	Information supplied by the manufacturer of medical devices
EN ISO 13485:2016	Medical Devices – Quality Management Systems – Requirements for Regulatory Purposes
ISO 14971:2019*	Medical Devices – Application of Risk Management to Medical Devices
EN ISO 15223-1:2021	Medical Devices-Symbols to be used with medical device labels, labelling and information supplied-Part1: General requirements
EN 1041:2008+A1:2013	Information supplied by the manufacturer of medical devices
EN 60601-1:2015/A1:2013	Medical electrical equipment — Part 1: General requirements for basic safety and essential performance
EN 60601-1-2:2015/A1:2021	Electromagnetic disturbances requirements and tests (EMC)
IEC 60601-1 6:2010+AMD1:2013+AMD2:2020	Medical electrical equipment - Part 1-6: General requirements for basic safety and essential performance - Collateral standard: Usability
BS EN 62304:2006+A1:2015	Medical device software – software life cycle processes
EN 62366-1:2015	Part 1: Application of usability engineering to medical devices

Equipment Classification:

Class II with respect to protection from electric shock.
 Type BF with respect to degree of protection from electric shock.
 Ordinary degree of protection against ingress of liquids.

SAFETY INFORMATION

Warning Statements and Warning Symbols:

 **WARNING: PLEASE FOLLOW THESE SYMBOLS AND INSTRUCTIONS CAREFULLY TO REDUCE RISK OF FIRE OR EQUIPMENT FAILURE**



TYPE BF APPLIED

- Equipment not suitable for use in the presence of a flammable anaesthetic mixture.
- Ground reliability is only achieved when the equipment is connected to a receptacle marked “**Hospital Only**” or “**Hospital Grade**”.



REFER TO INSTRUCTION MANUAL/BOOKLET

- Do not perform maintenance or service while device is in use.
- Keep charging dock and power supply cord in a place free of other equipment – power supply must be easy to disconnect from the outlet.
- Do not modify equipment.

Warnings – Refer to Appendix A, B, C, D (pg. 55)



DO NOT USE IF PACKAGE IS DAMAGED

Rx Only

PRESCRIBED DEVICE



CAUTION (USE WITH CAUTION)



NON STERILE



NON-DEHP

When packed for transport from factory, equipment will withstand:

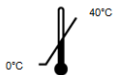

AMBIENT TEMPERATURE RANGE **0°C TO + 40°C**



RELATIVE HUMIDITY RANGE **10 % TO 100 %**



ATMOSPHERIC PRESSURE RANGE **50 kPa TO 106 kPa**

RAPID BAROSTAT BAG PUMP

GETTING STARTED



RBB PUMP COMPONENTS

RBB Pump package includes:

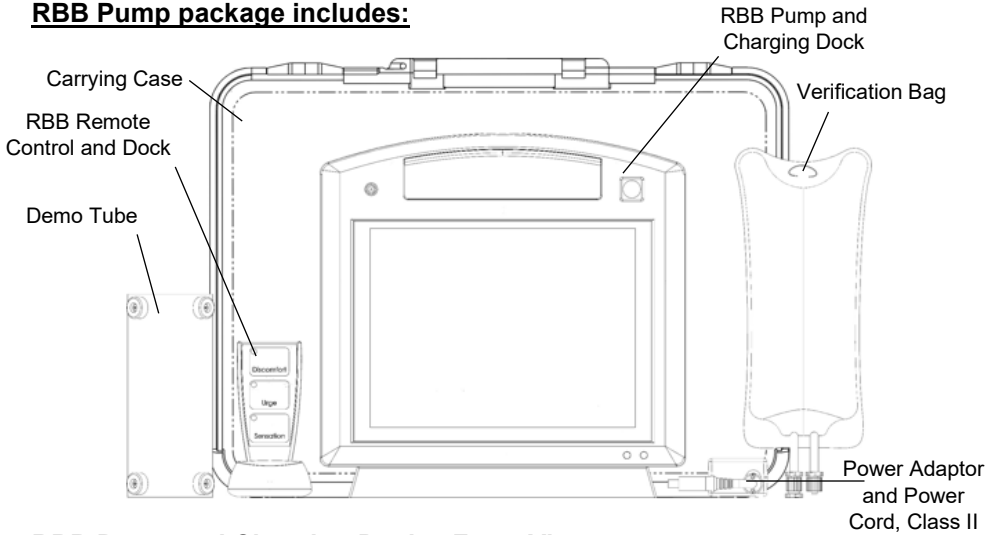

RBB Pump and Charging Dock – Front View:

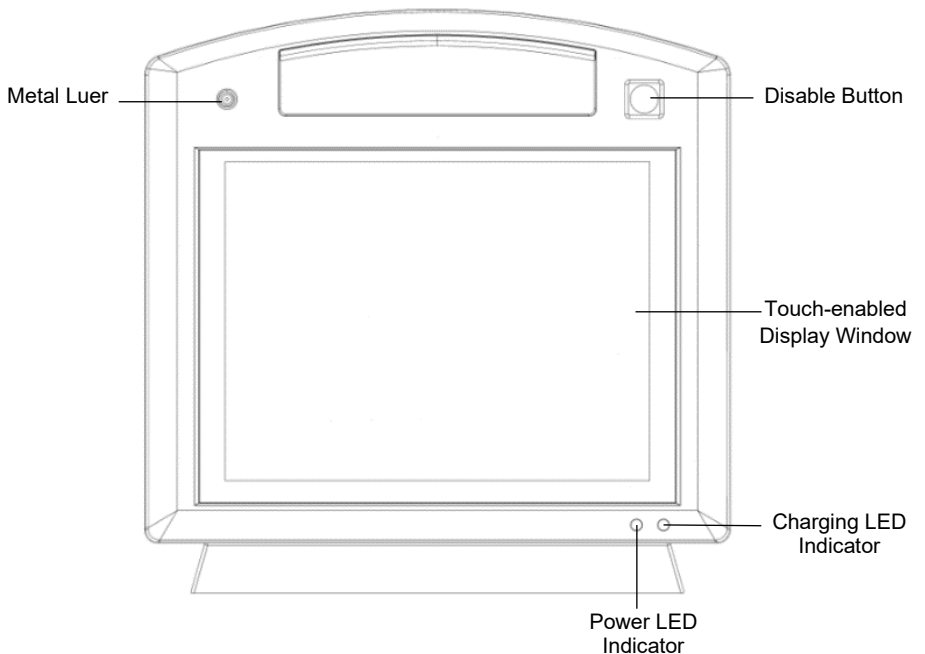

RBB PUMP COMPONENTS

RBB Pump and Charging Dock – Back Left View:

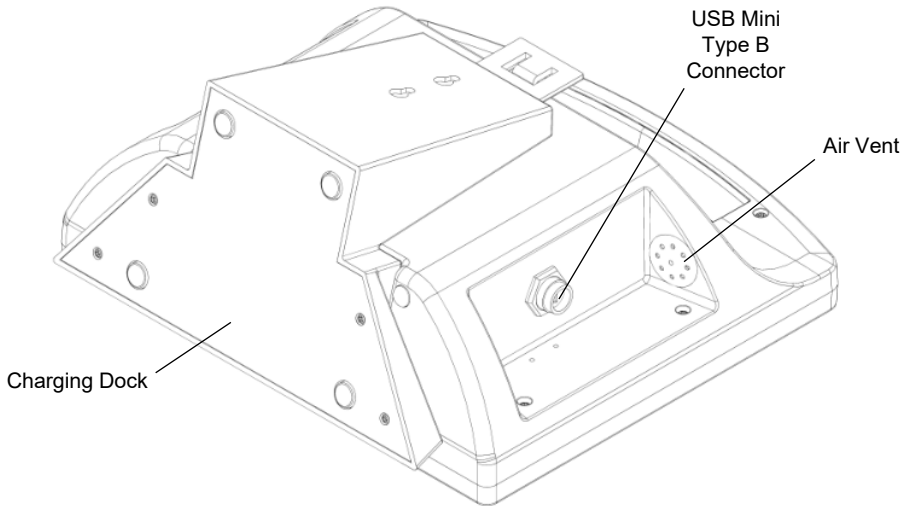

RBB Pump and Charging Dock – Back Right View:

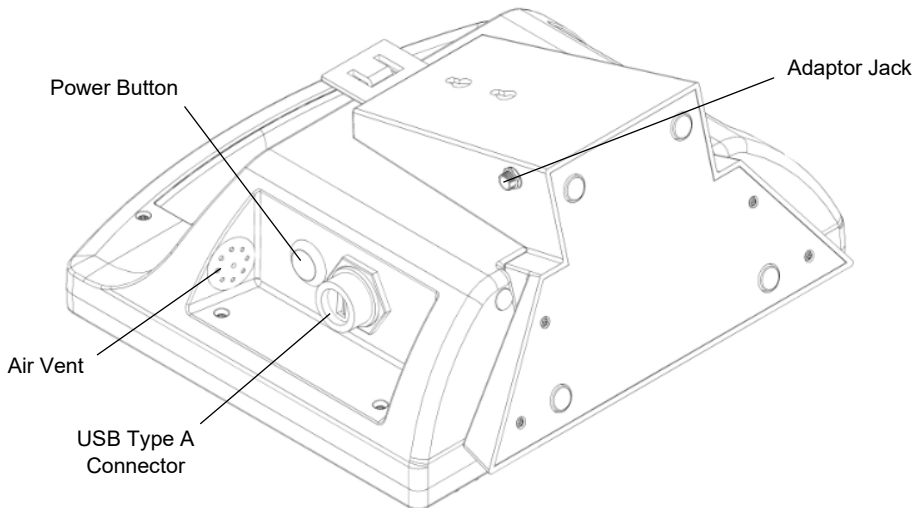

RBB PUMP COMPONENTS

Power Adaptor and Power Cord, Class II:

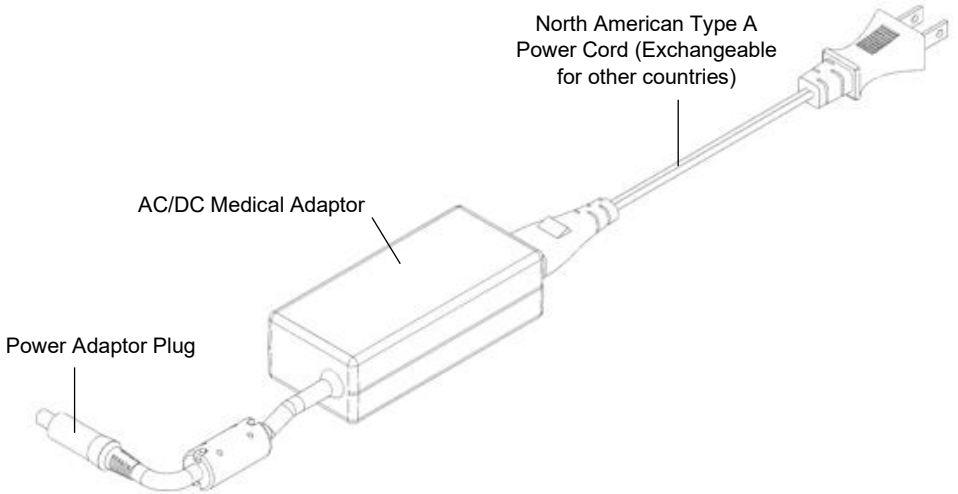

RBB Remote Control and Dock:

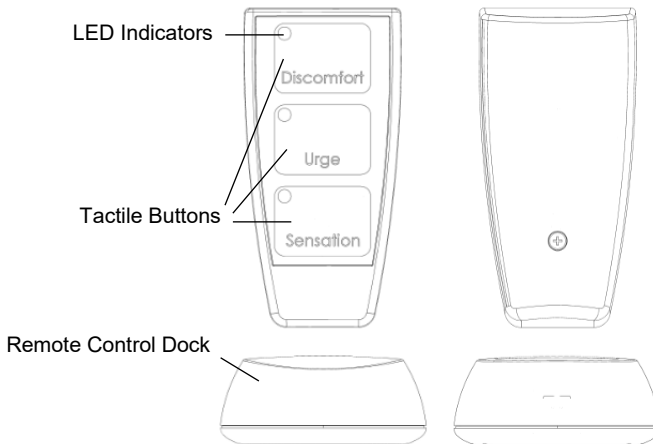

RBB PUMP COMPONENTS

Verification Bag:

Demo Tube:

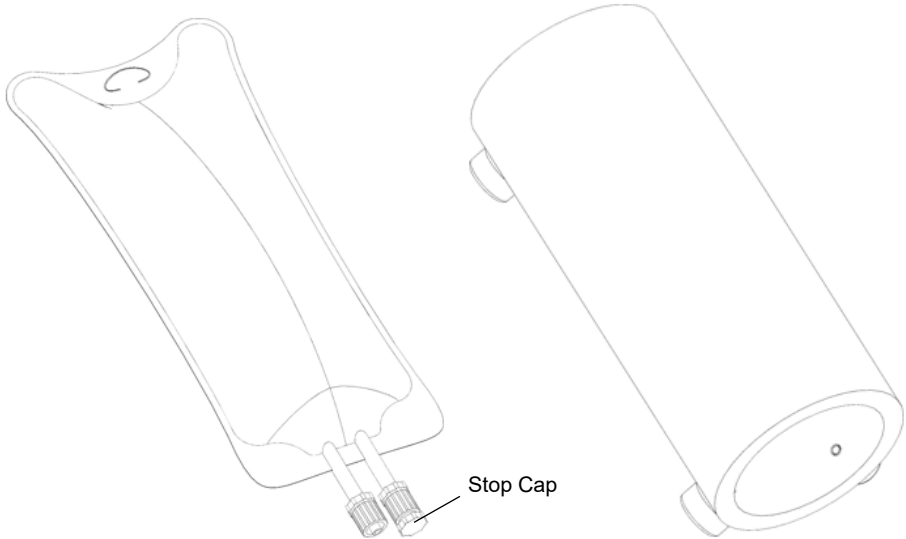

Carrying Case:

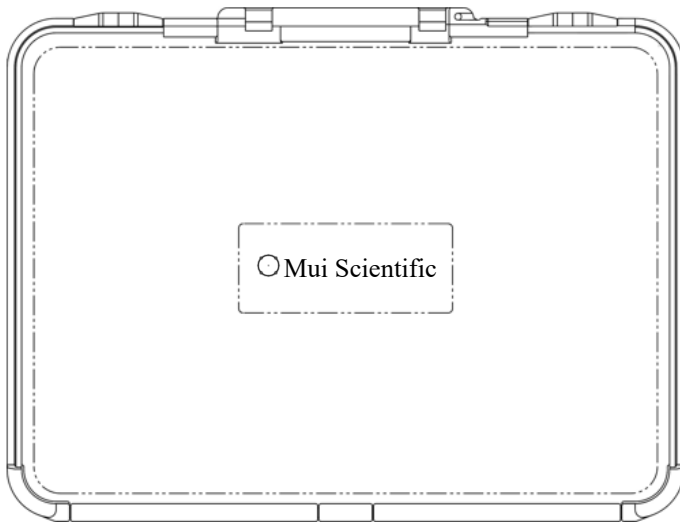

USING THE POWER ADAPTOR

Connecting the Power Adaptor:

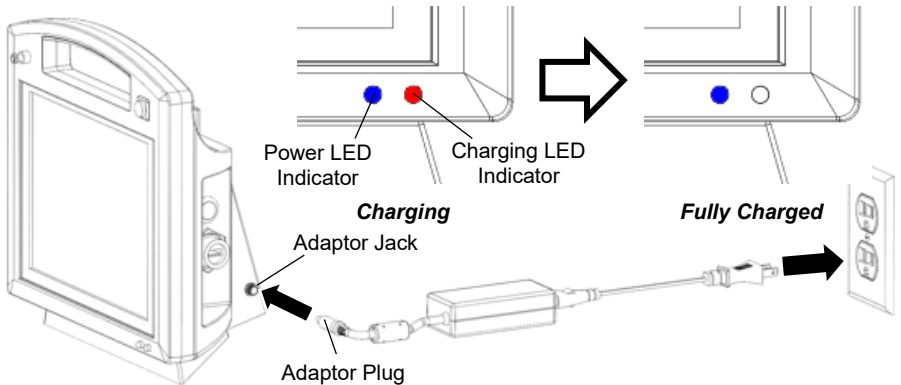

- 1) Insert Adaptor Plug into the Adaptor Jack on the bottom right side of the Charging Dock as illustrated.
- 2) Plug the Power Adaptor into any standard wall electrical outlet.
- 3) Both **BLUE** and **RED** LED Indicators at the front of the RBB Pump should light up, indicating that the pump is charging.
- 4) When the pump is fully charged, the **RED** LED will automatically turn off.

WARNING: DO NOT OVERCHARGE THE PUMP – DO NOT CHARGE THE PUMP OVERNIGHT WHEN IN USE EVERY DAY

Disconnecting the Power Adaptor:

- 1) Unplug the Power Adaptor from the wall electrical outlet.
- 2) Remove the Power Adaptor from the Charging Dock.

NOTE: The RBB Pump can operate for 4 hours of continuous operation and its charge can last for 4 months without use. Please charge the pump overnight before using if it is kept in storage for more than 4 months.

WARNING: PLEASE FOLLOW THESE INSTRUCTIONS CAREFULLY TO REDUCE RISK OF FIRE OR ELECTRIC SHOCK

- Use only the authorized RBB Adaptor provided in the package.
- For connection to a power supply outside of North America, use the appropriate Standard Power Cord for the respective country/region.
- Do not plug or unplug the power cord into electrical outlet with wet hands.

REMOTE CONTROL BATTERY

Installing Remote Control Batteries:

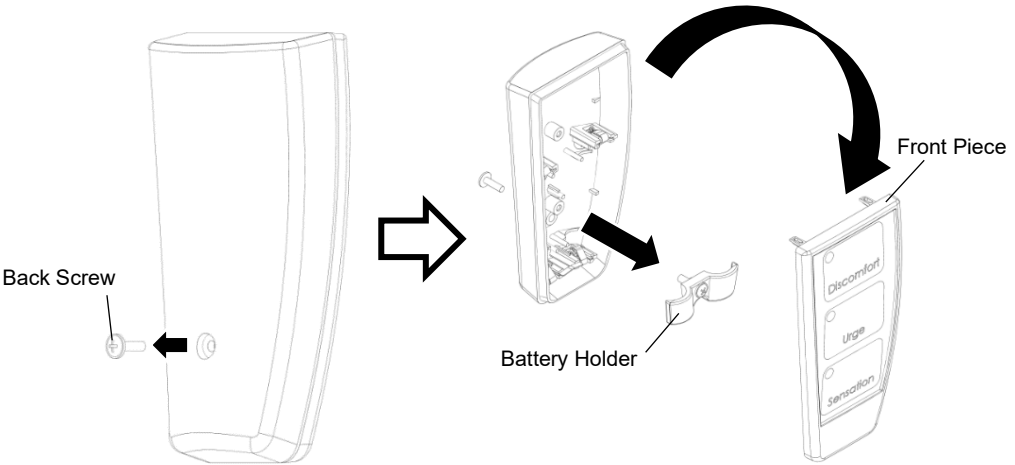

- 1) Unscrew the Back Screw on the back of the RBB Remote Control Case.
- 2) Separate the Front Piece of the RBB Remote Control Case.
- 3) Unscrew the Battery Holder inside the case.

- 4) Insert **2 AAA Batteries** into the battery compartment. Ensure that the + and – terminals on the battery matches with the polarities labeled in the battery compartment.
- 5) Reassemble the Remote Control by replacing the Battery Holder, Front Piece and Back Screw back to their original position.

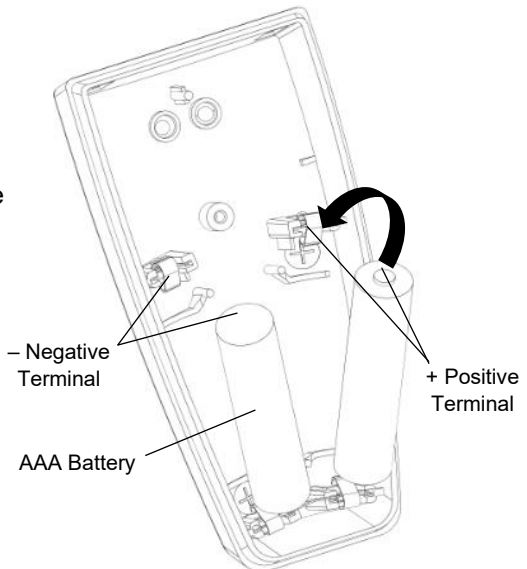

POWERING ON THE RBB PUMP

Powering On the RBB Pump:

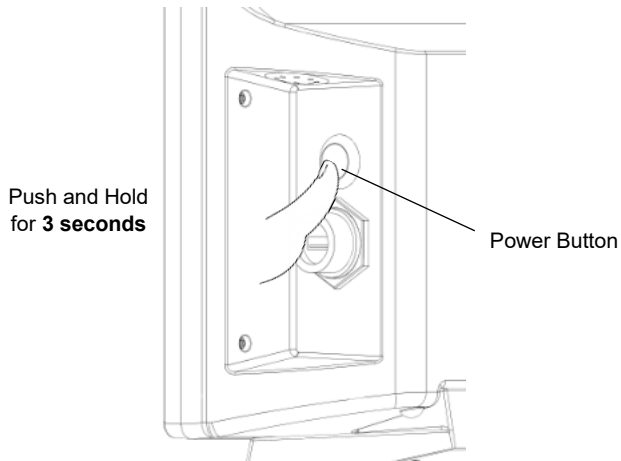

- 1) Push and Hold the Power Button on the right side of the Pump for **3 seconds**. This will start the RBB Pump's Boot Up Sequence.
- 2) Once the Boot Up Sequence is complete, the RBB Splash Screen will appear.



Rectal Motor And Sensory Function:
Rapid Barostat Bag Test

Mui Scientific

SELECT TO
IMPORT NEW
LETTERHEAD

HOSPITAL NAME
123 FOURTH STREET
TORONTO, ONTARIO, CANADA
A1B 2C3 (416) 555-4321



- 3) Touch anywhere on the screen to proceed to the pump's Main Menu (See pg. 15). Users may then power on and pair the RBB Pump Remote Control in the Device Unlock Screen (refer to page 16).

POWERING ON THE RBB PUMP

Navigating the Main Menu:



1. Title - *shows which operating screen is being displayed*
2. Bluetooth Icon
- *shows connection to Remote Control, and its battery level*
3. Battery Icon - *shows battery level of the pump*
4. Patient List - *shows all created patient profiles*
5. Options
 - Add New Patient - *add a new patient profile*
 - Patient Files - *sort, search and filter patient profiles*
 - Settings - *choose different settings for the pump and RBB Test*
 - Power Off - *power off or lock the pump*
6. Time and Date - *displays current time and date*

PAIRING THE RBB REMOTE

Pairing the Remote Control:

- 1) Hold the Remote Control within a meter of the RBB Pump and ensure that the RBB Pump has been turned on.
- 2) Press and Hold on the **GREEN** Sensation Button for **1 second**. This will wake the Remote Control from its SLEEP Mode and it will automatically search to pair with the RBB Pump.

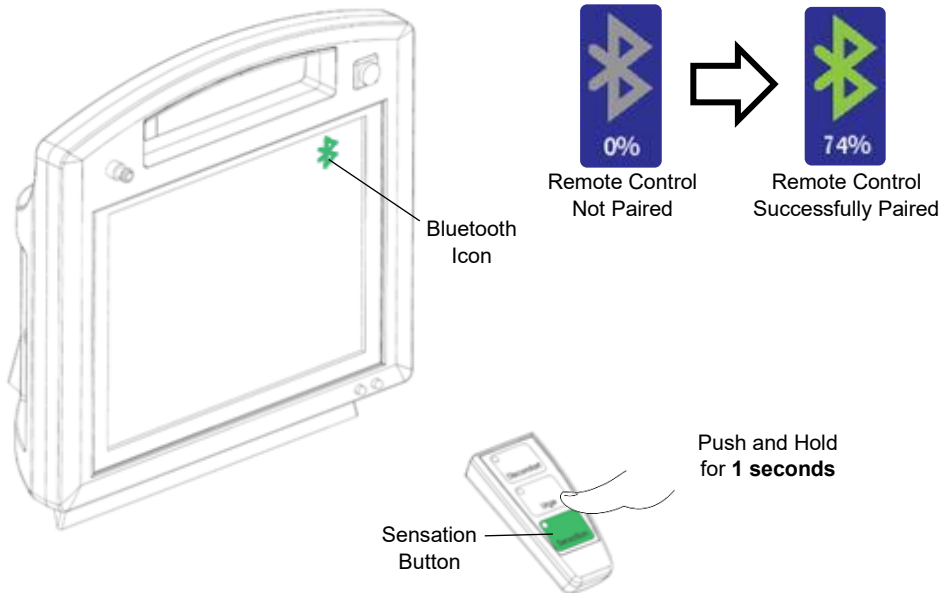

- 3) Verify if the Remote Control has successfully paired with the pump by looking at the Bluetooth Icon at the top right corner of the pump's screen. The icon will turn **GREEN** if the remote has been paired, otherwise it will stay **GRAY**.
- 4) Once the Remote Control has paired with the pump, it will stay in ACTIVE Mode. If there is no activity for **30 minutes**, the remote will automatically go back to SLEEP Mode to save power. Follow steps 1 to 3 to pair it with the pump again.
- 5) The Remote Control will also go back to SLEEP Mode when the pump is powered off. Users must follow steps 1 to 3 to pair the remote again the next time the pump is powered on.

PAIRING THE RBB REMOTE

Testing the Remote Control:

To check if the Remote Control is operating correctly, select the **GREEN** Bluetooth icon.



A popup screen containing Bluetooth information is displayed on screen. Users can then press the 3 different coloured buttons on the Remote Control and check if the corresponding coloured squares beneath the GREEN Bluetooth icon are flickering in response.

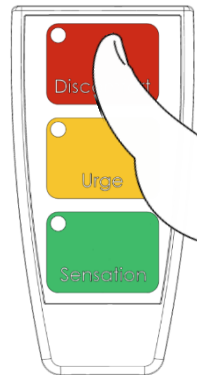
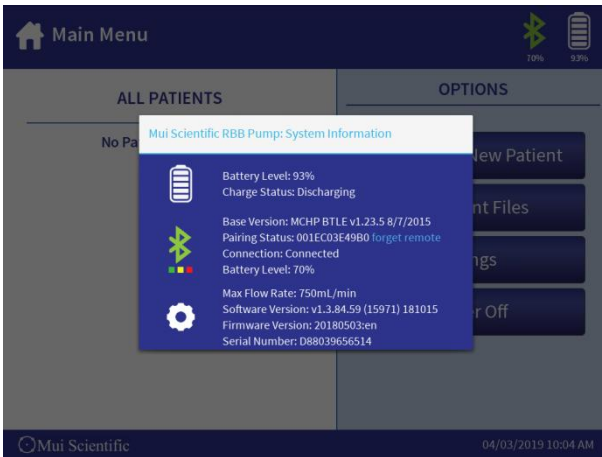

The Remote Control is operating correctly if all 3 coloured squares flicker in response to their respective coloured buttons when pressed.

Note: The RBB Pump System Information popup screen also contains information on the pump's software, firmware version and battery level.

FIRST TIME SETUP

Setting Up Password Protection:

To ensure security protection of their RBB Pump, users are encouraged to create a systems password. The following steps show how to create a systems password.

- 1) In the Main Menu screen, select the **“Settings”** button.

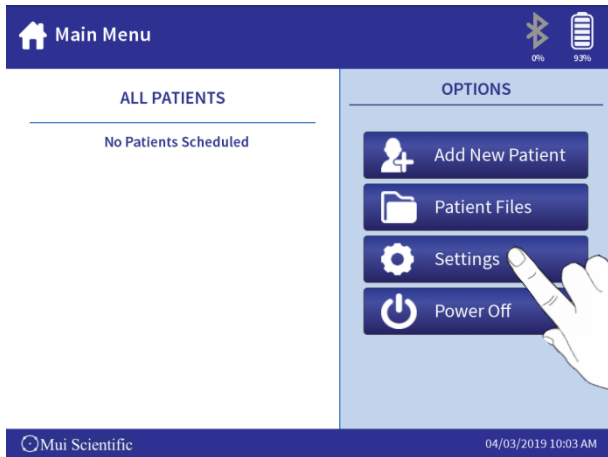

- 2) Select the **“System Settings”** Tab.

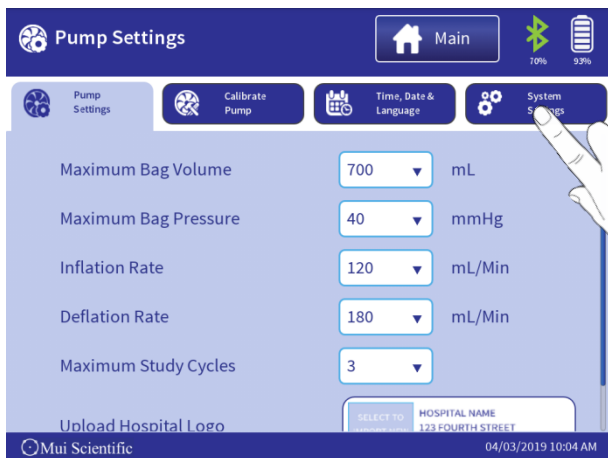

FIRST TIME SETUP

3) Select the “Enable Password” Button.

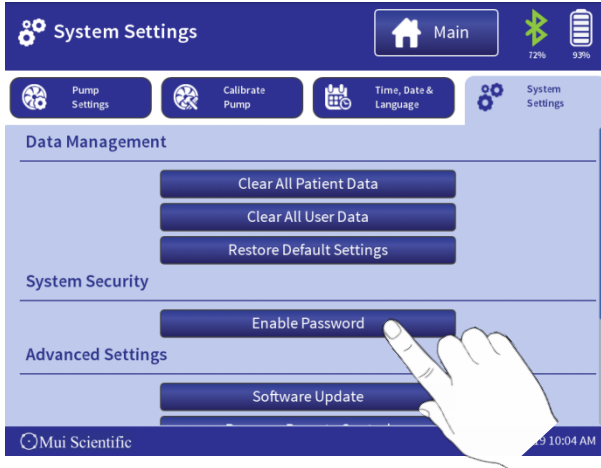

4) Enter the desired Password in both fields.

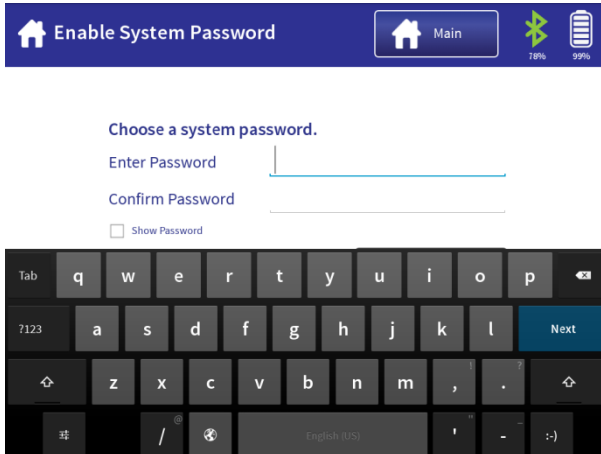

5) Once the Systems Password is created, users can return to “**System Settings**” to change or remove the password. To recover forgotten password, go to page 59 “**Resetting Password**” for more information.

FIRST TIME SETUP

Default Pump Settings:

To perform a standard RBB Test, users must verify if the settings in the pump are set to the **default values**.

- 1) To verify/change the settings, select the “**Settings**” button in the Main Menu Screen, and then select the “**Pump Settings**” tab.



- Maximum Bag Volume
 - sets the maximum volume that the Barostat Bag will inflate to
 - Maximum Bag Pressure
 - sets the maximum pressure that the Barostat Bag will inflate to
 - Inflation Rate
 - sets the default rate of air entering the Barostat Bag
 - Deflation Rate
 - sets the default rate of air exiting the Barostat Bag
 - Maximum Study Cycles
 - sets the maximum number of times that a user can perform the Sensation Test (see pg. 32)
- 2) The values shown in the picture are the **default values** used to perform a standard RBB Test. Users may change these values according to their testing requirements (e.g. For pediatric purposes). These values can also be restored to their default values (see pg. 45)

3) Select **“Save”** button

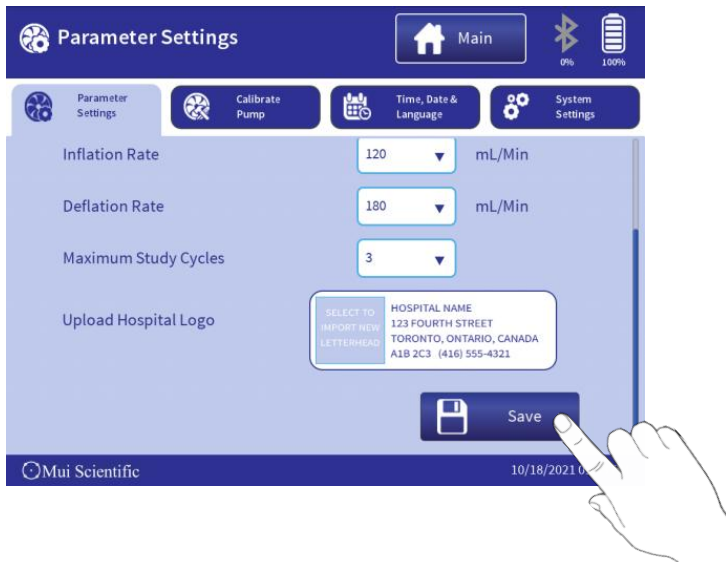

FIRST TIME SETUP

Uploading Hospital Logo:

The RBB Pump gives users the ability to upload their own Hospital Logo such that it will appear on the RBB Splash Screen and the RBB Test Report.

- 1) Users must first save an image file of their hospital logo into a USB Mass Storage Device. The recommended file types are **.jpeg**, **.gif** and **.png**, and the recommended size for the image is within **400 x 250 pixels**.
- 2) Insert the USB Mass Storage Device into the USB Type A Connector at the right side of the Pump.

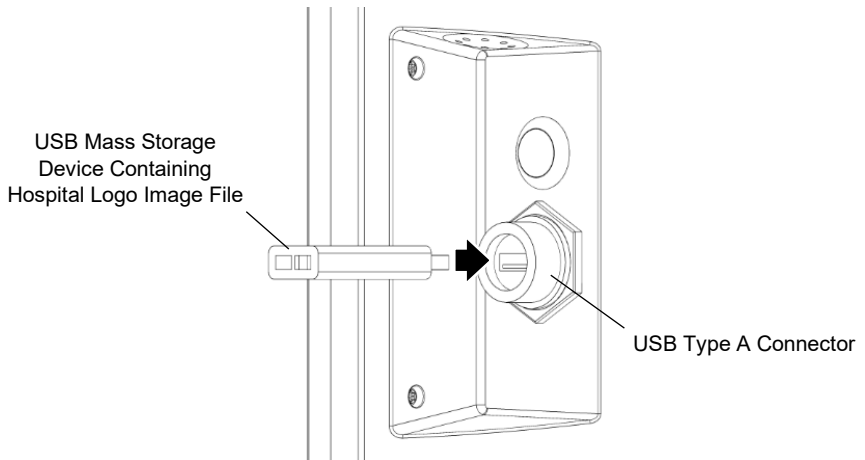

- 3) Once the USB device has been securely plugged into the pump, verify that the pump has successfully detected the USB device. A USB Icon will appear on the top right corner of the screen, to the left of the Bluetooth and Battery Icons.

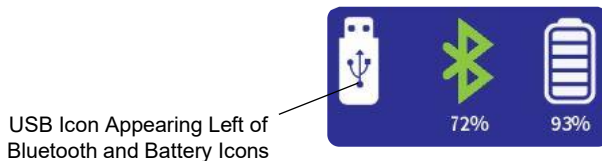

FIRST TIME SETUP

- 4) In the Pump Settings Screen, select the “Upload Hospital Logo” Box

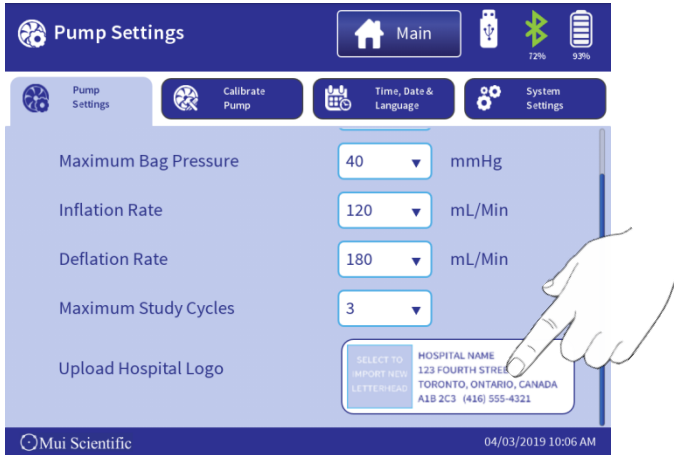

- 5) A popup will appear that shows the images stored inside the USB device. Select the correct hospital logo image file.

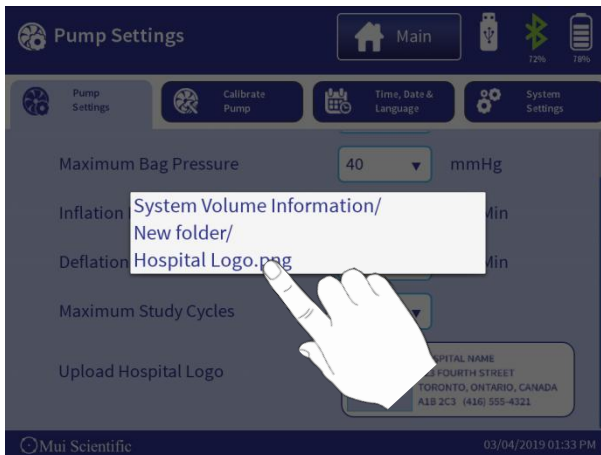

- 6) The pump then automatically uploads the logo into its system. The USB Mass Storage Device may then be unplugged from the pump.

FIRST TIME SETUP

Setting the Time and Date:

- 1) In the Device Settings Screen, select the “Time, Date & Language” tab.



- 2) Change the Time and Date by scrolling through the “Set Time” and “Set Date” dials. Users can also set their preferred Time and Date Formats.
- 3) Select desired language from the “Language” Dropdown menu.

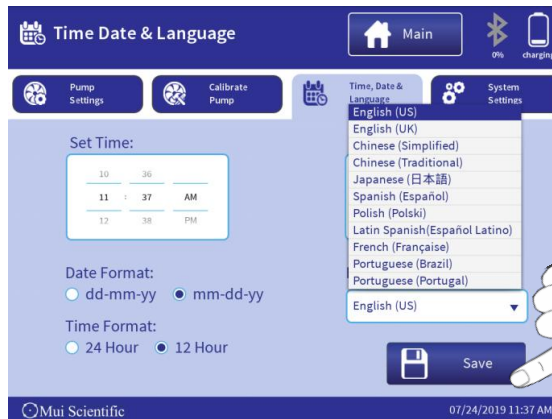

NOTE: User must change the language of the keyboard when choosing language – follow Changing Keyboard Language on page 27.

- 4) Select the “Save” Button to save all changes.

FIRST TIME SETUP

Changing Keyboard Language:

NOTE: User must change the language of the keyboard when choosing language.

- 1) To change the keyboard's language, select a typeable field, such as the **"Last Name"** field below, to bring out the keyboard. Push and hold the **"Globe"** or **"Spacebar"** icon on the keyboard to bring out the keyboard's language selection list. Selecting the **"Globe"** icon once will change the keyboard's language to the next language on the selection list.

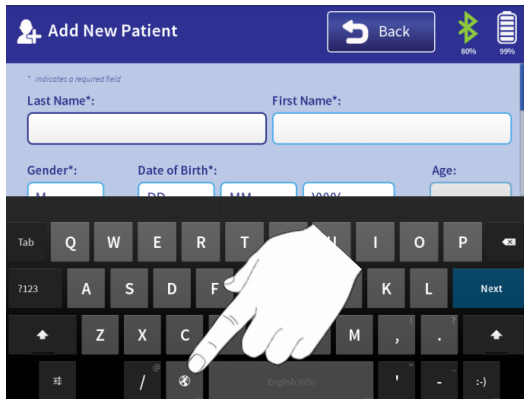

- 2) Select desired language from the list to change the keyboard. Contact Mui Scientific if you wish to type in a language that is not shown on the list.

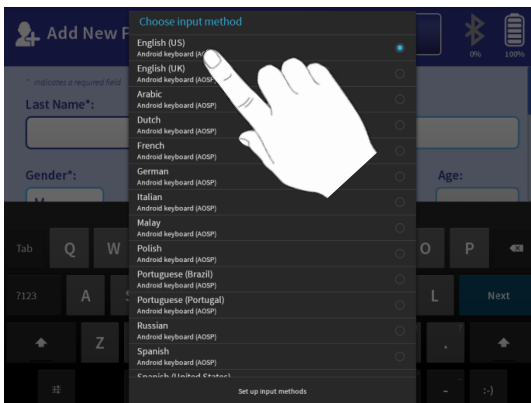

RAPID BAROSTAT BAG PUMP

OPERATING INSTRUCTIONS



PATIENT INFORMATION

Adding a New Patient Profile:

Before performing any test, users must first select or create a patient profile.

- 1) Select the **“Add New Patient”** button in the Main Menu Screen (see pg. 15). The Add New Patient Screen will appear.

The screenshot shows the 'Add New Patient' screen with the following fields and values:

- Last Name*:
- First Name*:
- Gender*:
- Date of Birth*:
- Age:

A keyboard is visible at the bottom of the screen.

- 2) Fill in the fields accordingly and then select the bottom **“Save”** button. Ensure **“Patient ID”** is unique; duplicate **“Patient ID”** will not be saved.

Patient Profile
“John Smith”
is Created

The screenshot shows the 'Add New Patient' screen with the following fields and values:

- Last Name*:
- First Name*:
- Gender*:
- Date of Birth*:
- Age:
- Patient ID*:
- Other ID:
- Insurance:
- Physician's Name*:
- Ref. Physician's Name:

The bottom of the screen shows the Mui Scientific logo and the date/time: 03/04/2019 10:26 AM.

Unique
“Patient ID”

PATIENT INFORMATION

- 3) Once the Patient profile has been created, it will appear on the Main Menu Screen's Patient List.

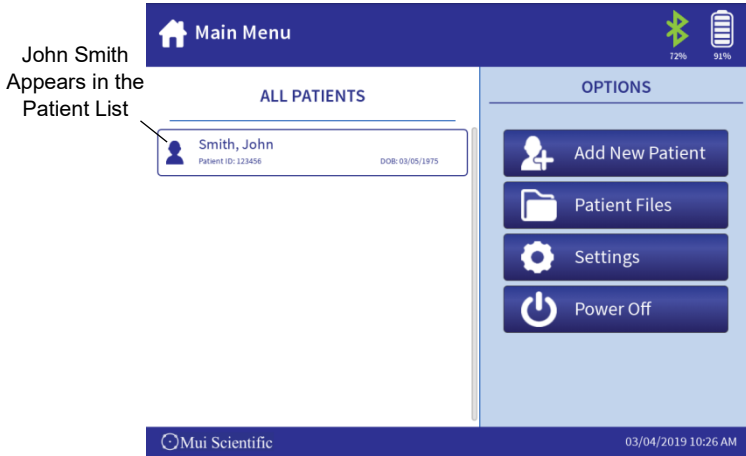

Editing Patient Information:

- 1) Select the patient from Main Menu to access the Patient Profile Screen.

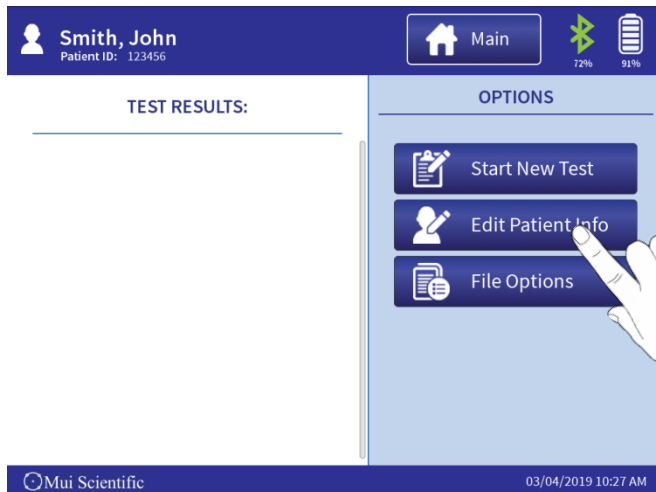

- 2) The patient's information can be edited by selecting the "Edit Patient Info" button and editing the fill-in fields.

BEFORE PERFORMING A TEST

Connecting the RBB Catheter:

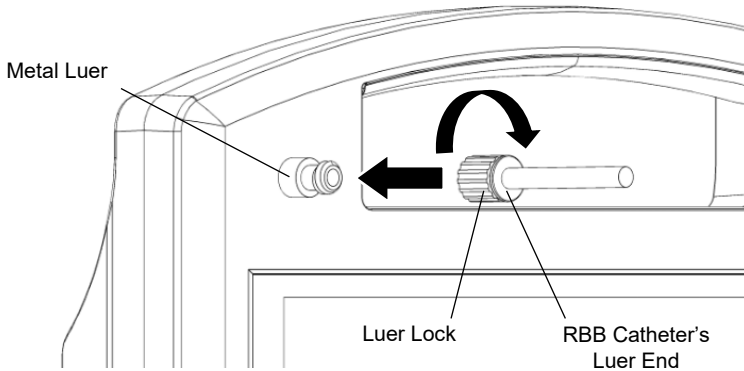

- 1) Securely attach the RBB Catheter's Luer End into the pump's Metal Luer.
- 2) Tightly twist the Luer Lock onto the Metal Luer.

toggling the Disable Button:

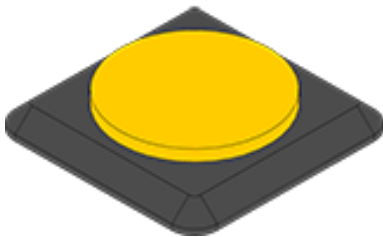

Disable Button
DEPRESSED
(RBB Pump Operational)

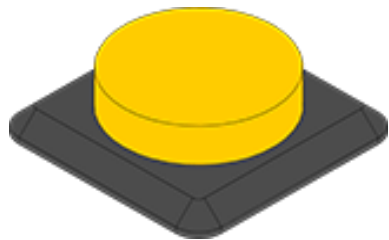

Disable Button
RAISED
(RBB Pump Disabled)

- 1) The Disable Button is an OFF switch for all of the pump's pneumatic components. When it is in a RAISED state, it will shut off all pneumatic components and all air is expelled from the RBB Catheter (if it is connected).
- 2) Ensure the Disable Button is DEPRESSED before performing any test. The pump will not run if the Disable Button is RAISED.

BEFORE PERFORMING A TEST

 **WARNING: PLEASE FOLLOW THESE INSTRUCTIONS CAREFULLY TO PREVENT POTENTIAL HARM TO PATIENTS**

- Do not use RBB Catheter if damaged or expired.
- Do not reuse RBB Catheter.
- Remove the RBB Catheter from the patient immediately if the patient is displaying a negative reaction or significant discomfort.
- In the event that the software crashes during a test, the compressor motor and all air valves within the RBB Pump will return to their default state of powered off and all valves open. The balloon of the RBB Catheter within the patient will immediately deflate.
- In the event that the software freezes during a test, there is the risk of the compressor motor remaining locked in the inflation state. At this time, the Disable Button should be immediately toggled to the RAISED position. This will physically remove power from all components within the RBB Pump, thereby powering off the compressor motor and opening up all the air valves. The balloon of the RBB Catheter within the patient will immediately deflate.
- In the event that the Disable Button malfunctions, the RBB Catheter should be manually disconnected from the metal luer on the RBB Pump. The balloon of the RBB Catheter within the patient will immediately deflate.

PERFORMING AN RBB TEST

To perform an RBB Test, users must first navigate to the Patient Profile Screen. In this example, we will use John Smith who was added previously (see pg. 24).

Starting a New Test:

- 1) Select the **“Start New Test”** button. A popup screen will appear with RBB Test settings.



- 2) Users can add/choose an Operator and change the RBB Test settings. Select the **“Start Test”** button when ready.



PERFORMING AN RBB TEST

Users must first ensure the RBB Catheter is securely connected to the pump. Then, they can begin the Capacity Test as described below.

Performing a Capacity Test:

- 1) Select the “**Empty Bag**” button. The pump will start removing residual air.



- 2) The pump will automatically stop once the bag is sufficiently deflated.

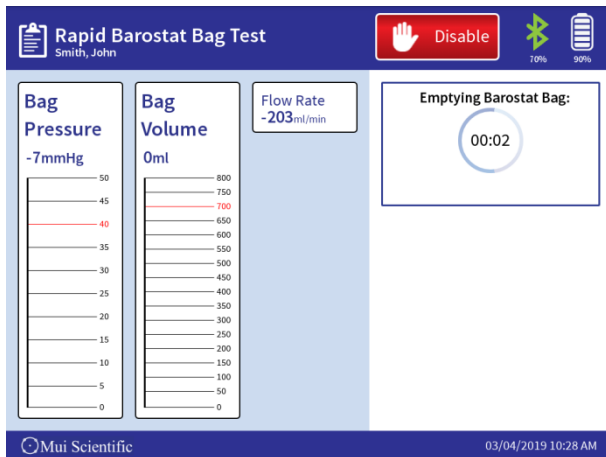

PERFORMING AN RBB TEST

- 3) Select the “Start Capacity Test” button to begin performing the Capacity Test.

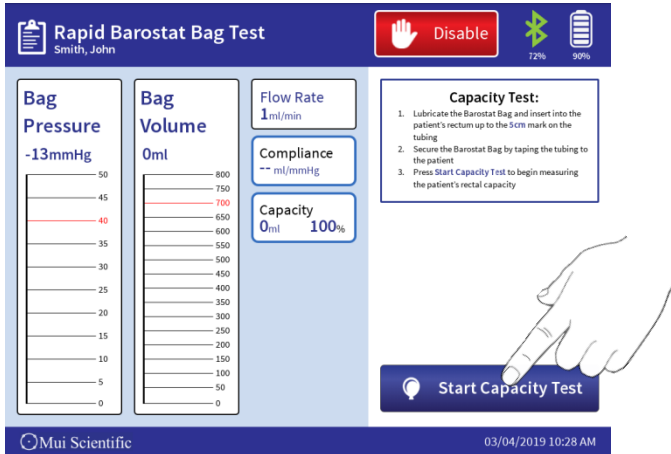

- 4) The test will automatically run until Rectal Capacity is calculated. Users can select the on-screen “Disable” or “Discomfort” button at any time to stop the test. Selecting the on-screen “Disable” button will stop the RBB Test completely, whereas selecting “Discomfort” button will proceed to the Sensation Test.

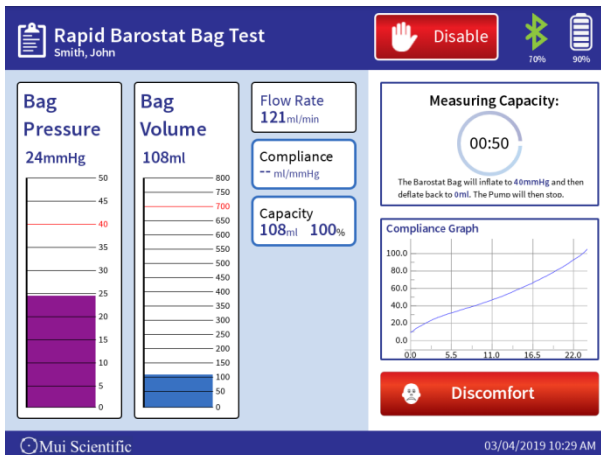

PERFORMING AN RBB TEST

- 5) Once the Rectal Capacity has been reached, the pump will automatically start to deflate the Barostat Bag until all air is removed from the bag.

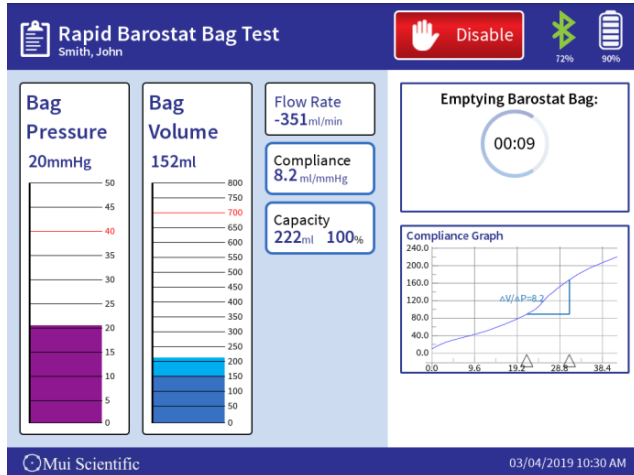

NOTE:

- When the Barostat Bag reaches desired pressure (40mmHg as default), the bag will continue to inflate for 5 more seconds while simultaneously monitoring the pressure within.
- If the pressure within the Barostat Bag is maintained during these 5 seconds, the RBB pump will take the volume of the bag at the end as Rectal Capacity.
- If the pressure within the Barostat Bag drops during these 5 seconds, monitoring will end and RBB pump will resume its inflation stage.

This feature is to prevent tests from prematurely stopping due to breathing artifacts, sneezing, coughing, involuntary reflexes, etc.

PERFORMING AN RBB TEST

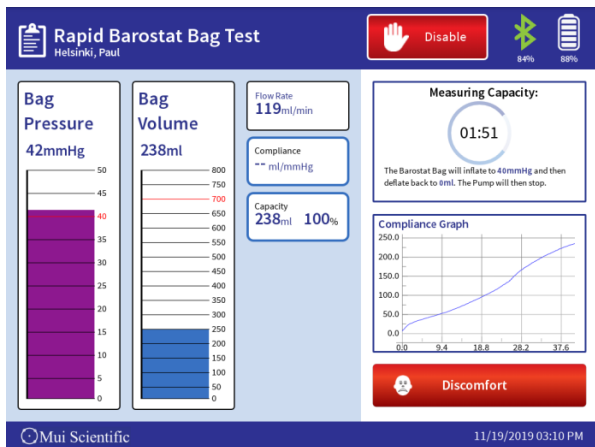

- 6) When the air has been removed from the Barostat Bag, the pump will automatically ready itself for the Sensation Test. The values for Rectal Capacity, Pressure and Compliance are stored into the pump. If the value for Rectal Compliance is not calculated using the desired slope of the graph, users have the ability to change it in the Test Report after the Sensation Test is complete (see pg. 38).

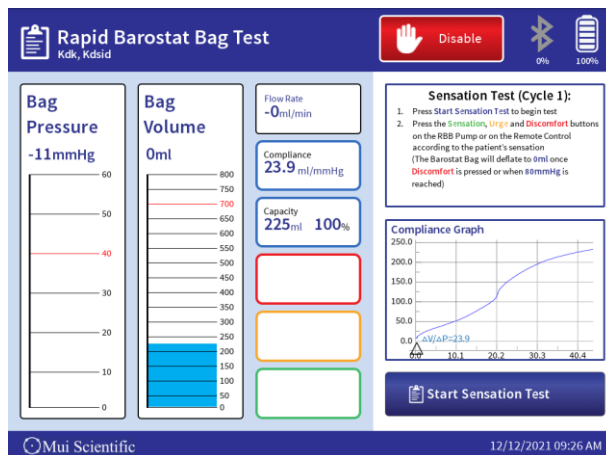

PERFORMING AN RBB TEST

Performing a Sensation Test:

- 1) Select the “**Start Sensation Test**” button to begin performing the Sensation Test.



- 2) The pump will begin inflating the Barostat Bag again. However, users must now provide input to the pump for the **3** sensitivity stages: **Sensation**, **Urge** and **Discomfort**. Select the “**Sensation**” button to indicate for the **Sensation** sensitivity stage (Either on-screen or on the RBB Remote Control).

PERFORMING AN RBB TEST

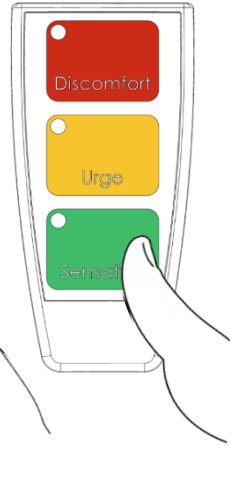
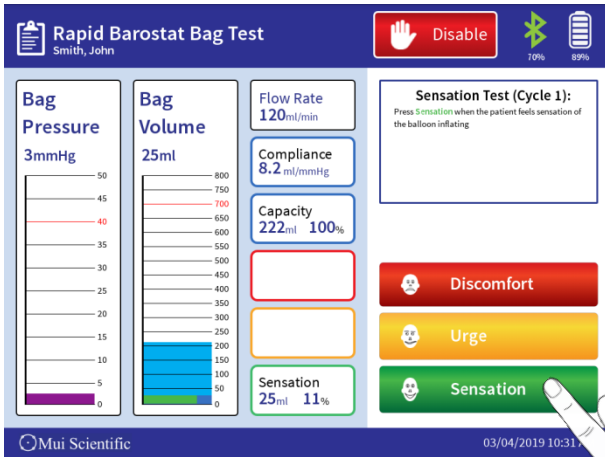

- 3) After selecting Sensation, the pump will register and display the volume at which **Sensation** is reached. The pump also displays the volume as a percentage of the Rectal Capacity. Select the **Urge** button to proceed to the **Urge** sensitivity stage.

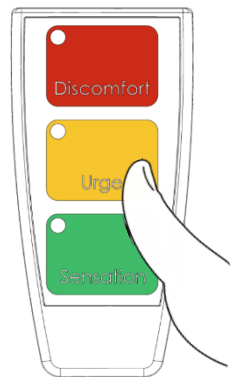
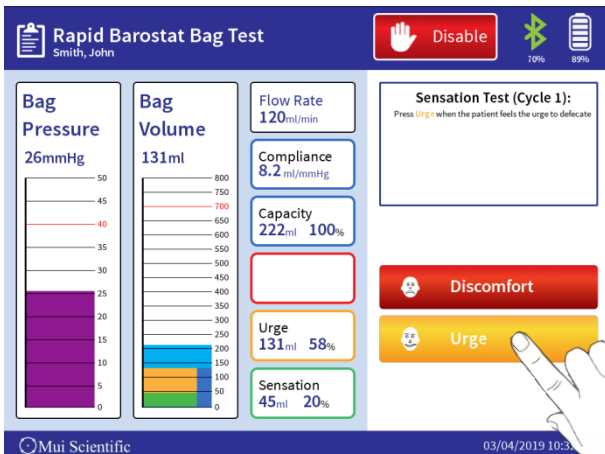

PERFORMING AN RBB TEST

- Finally, select the “**Discomfort**” button to indicate for the **Discomfort** sensitivity stage. This will complete 1 study cycle of the Sensation Test.

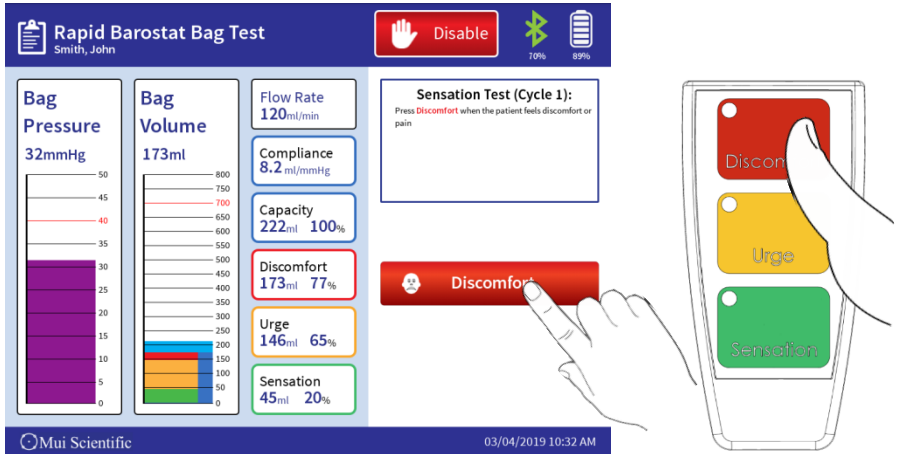

- Once the Sensation Test is complete, the pump will automatically deflate the Barostat Bag. All data collected during the RBB Test is displayed on the screen and is stored in the pump as a test report and raw data. Users can access the test report from the patient’s profile (see pg. 35).

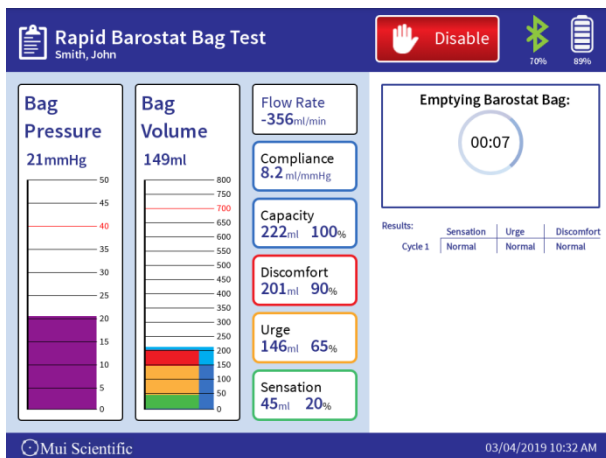

NAVIGATING A TEST REPORT

- 6) When all air is expelled from the Barostat Bag, the RBB Test will conclude. Users can choose to start a new sensation test by selecting the “**Start New Cycle**” button or exit back to the Patient Profile Screen by selecting the “**End Study**” button.

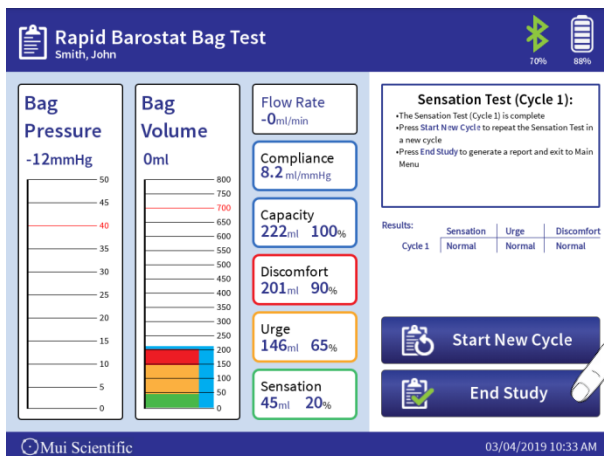

Once an RBB Test is complete, an RBB Test Report is generated for the patient. Navigate to the patient's profile to view the report.

Viewing a Test Report:

- 1) An RBB Test Report is generated under John Smith's profile. Select the “**Test 1: RBB**” button under Test Results List to view the Test Report Screen.

NAVIGATING A TEST REPORT

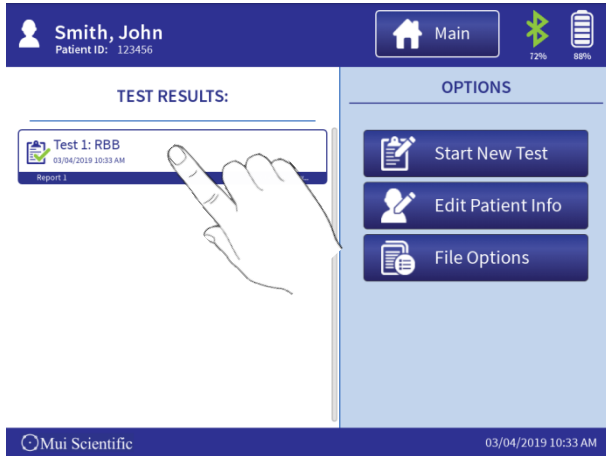

- 2) The report contains the patient's information and all test data collected during the RBB Test. Users can scroll down to view other report options.

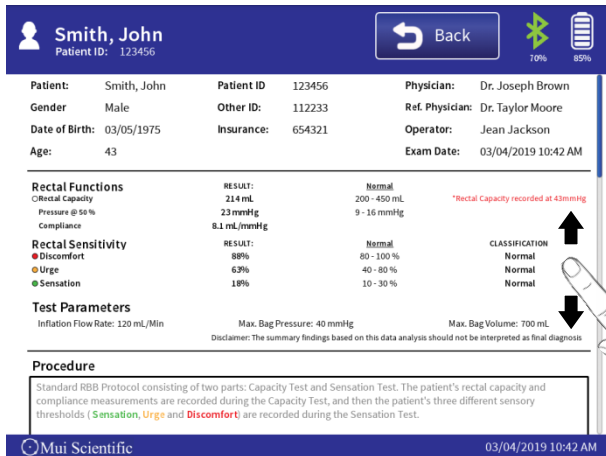

For patients who have completed multiple cycles on the Sensation Test, the RBB pump allows users to hide any Sensation Test cycles deemed non-applicable.

NAVIGATING A TEST REPORT

Hiding Sensation Cycles:

- 1) Scroll to the bottom of the Test Report Screen and select the “Edit Report” button. The RBB Report will enter “Edit Mode”

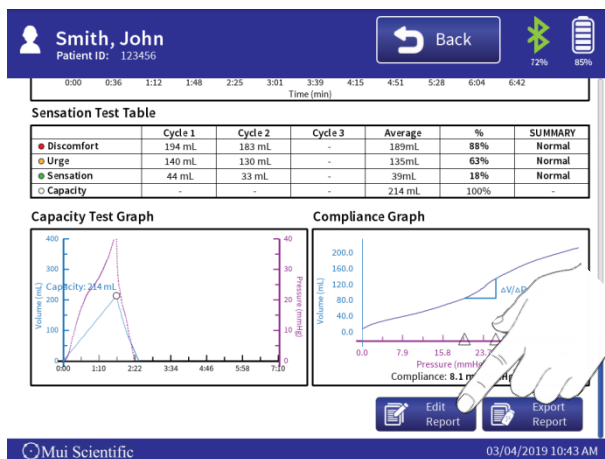

- 2) A check box will appear beside each cycle. Uncheck the boxes to hide their respective sensation cycle.

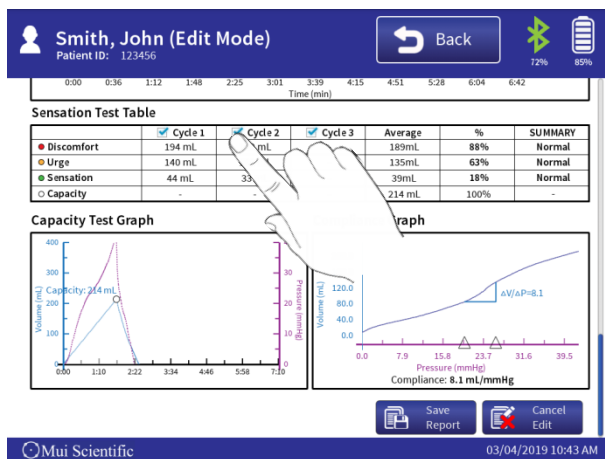

NAVIGATING A TEST REPORT

- 3) Once unchecked, all data within that sensation cycle will be removed from the report. The data will not be plotted onto the Sensation Graph and it will not appear in the exported test report. Users can check the box again if they wish to view that sensation cycle again. Select the **“Save Report”** button to save any changes made to the report.

Smith, John (Edit Mode)
Patient ID: 123456

Time (min): 0:00 6:36 1:12 1:48 2:25 3:01 3:39 4:15 4:51 5:28 6:04 6:42

Sensation Test Table

	<input checked="" type="checkbox"/> Cycle 1	<input type="checkbox"/> Cycle 2	<input checked="" type="checkbox"/> Cycle 3	Average	%	SUMMARY
Discomfort	194 mL	183 mL	-	194mL	91%	Normal
Urge	140 mL	130 mL	-	140mL	65%	Normal
Sensation	44 mL	33 mL	-	44mL	21%	Normal
Capacity	-	-	-	214 mL	100%	-

Capacity Test Graph

Volume (mL) vs. Time (min). Capacity: 214 mL.

Compliance Graph

Volume (mL) vs. Pressure (mmHg). Compliance: 8.7 mL/mmHg.

Buttons: Save Report, Cancel Edit

Mui Scientific 03/04/2019 10:43 AM

NAVIGATING A TEST REPORT

The RBB Pump can automatically approximate a Compliance Value using the slope of the Compliance Graph. However, the chosen values used to calculate this approximation can be unsuitable at times. Users can change the Compliance Value manually.

Changing the Compliance Value:

- 1) Ensure the pump is in Edit Mode, and then select the Compliance Graph on the right of the Test Report Screen.

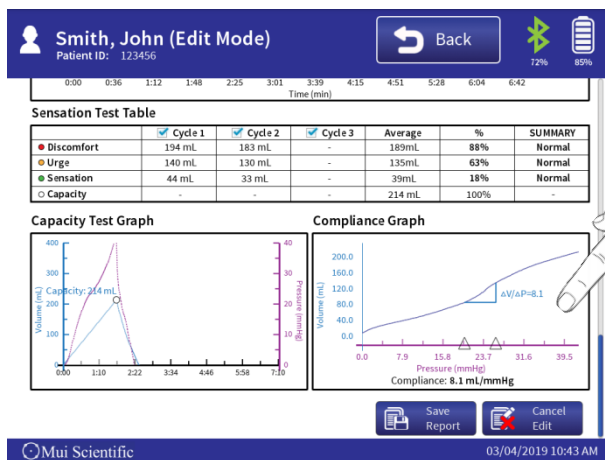

NAVIGATING A TEST REPORT

- 2) Drag finger on the screen to find the appropriate slope for calculating the Compliance Value.

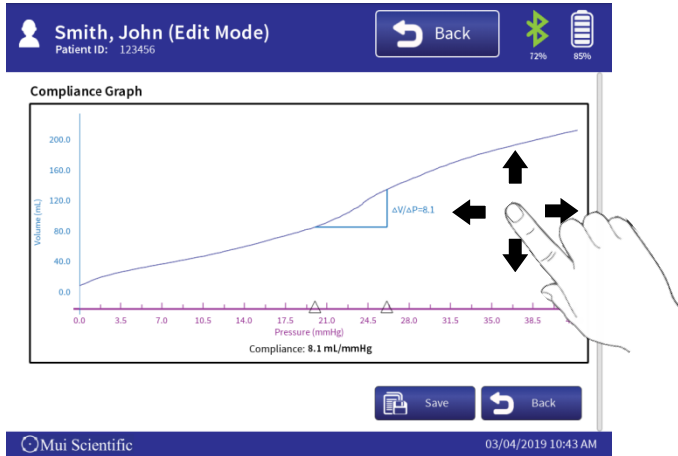

- 3) Once the appropriate slope for calculating Compliance Value is chosen, select the “Save” button to save the changes.

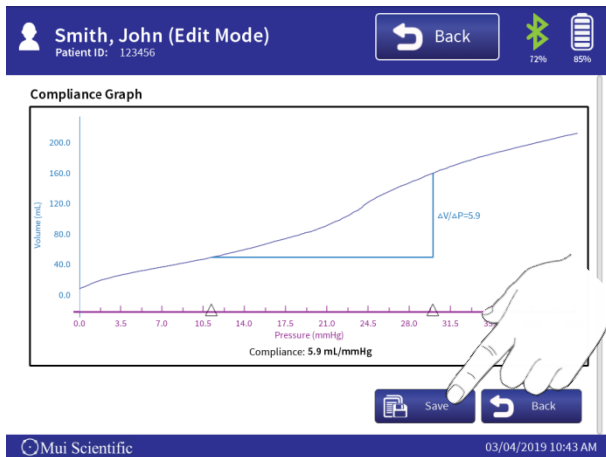

NAVIGATING A TEST REPORT

The RBB pump allows users to add, change or edit Procedure, Indications, Summary and Comments fields to every test report.

Editing Fields:

- 1) Ensure the RBB Report is in Edit Mode, and then select the any of the 4 different field boxes (“**Comments**” shown below).

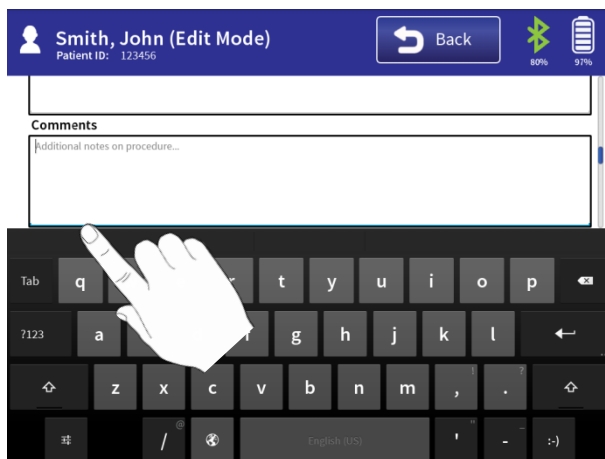

- 2) Add, edit or change any entries into the selected field using the keyboard. Select the “**Save Report**” button to save changes made.

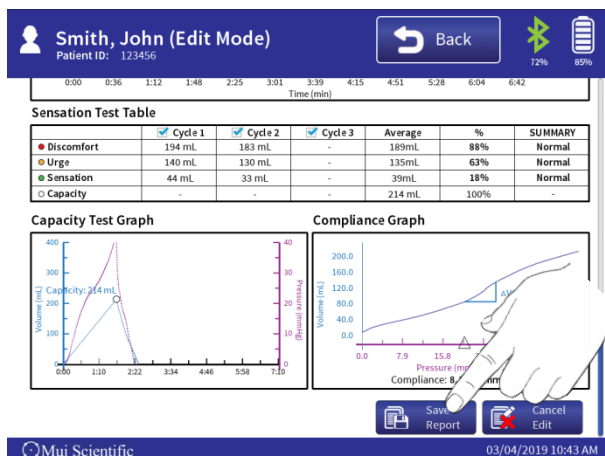

EXPORTING FILES

The RBB Pump allows users to export the test reports and raw data stored in the pump to a USB Mass Storage Device or to a computer. Test reports are exported in **.pdf** format for ease of printing, whereas raw data is exported in **.csv** format that can be read by data processing software (e.g. Microsoft Excel).

USB Mass Storage Device

USB Type A Connector

Exporting a Test Report to a USB:

- 1) Before exporting the report, users must first plug a USB Mass Storage Device to the right side of the pump. Ensure that the USB device is detected by the RBB Pump by verifying that the USB Icon appears at the top right corner of the screen.

Note: Please do not to use a formatted USB device for transferring data from pump to USB.

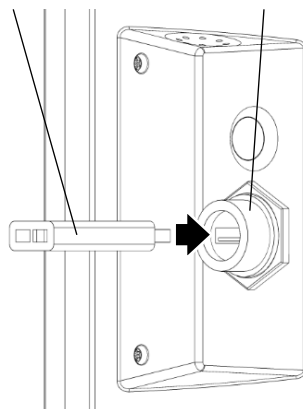

- 2) Scroll to the bottom of the test report and select the **“Export Report”** button at the bottom right corner. This will bring up a popup screen containing different export options for the test report.

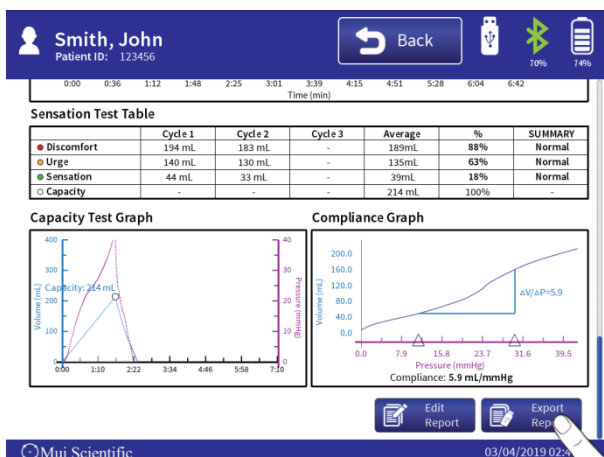

EXPORTING FILES

- 3) There are 3 options that are displayed in this popup screen:
- Exclude Graphs and Tables
 - Exports only the first page of the report into .pdf format; does not include graphs and table.
 - Exclude Personal Info. from Report
 - Does not display personal information on pdf report.
 - Include Raw Data File
 - exports .csv raw test data collected during the test along with .pdf report
- Select any option as necessary, and then select “Export”.

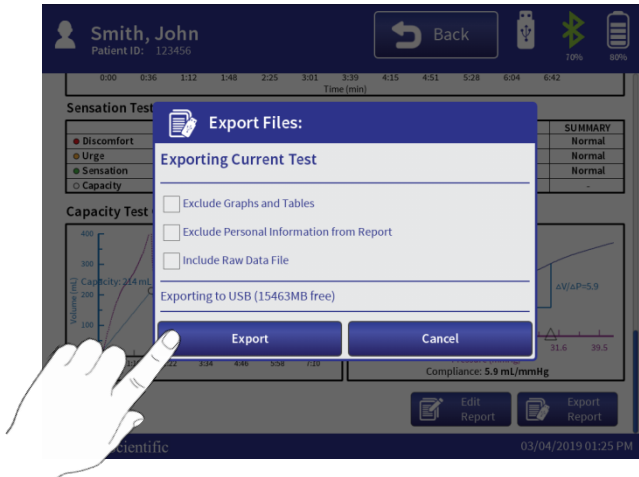

- 4) The export process will take approximately **10 seconds**. A popup window will appear indicating that the report is being exported. Once the export is complete, users may remove the USB Mass Storage Device from the pump.

EXPORTING FILES

Exporting a Test Report to a Computer:

- 1) To export a Test Report to a computer, the user must first create the report and store it into the pump. Simply export the report in the “Export Files” popup window without a USB device connected to generate the test report and store it into the pump.

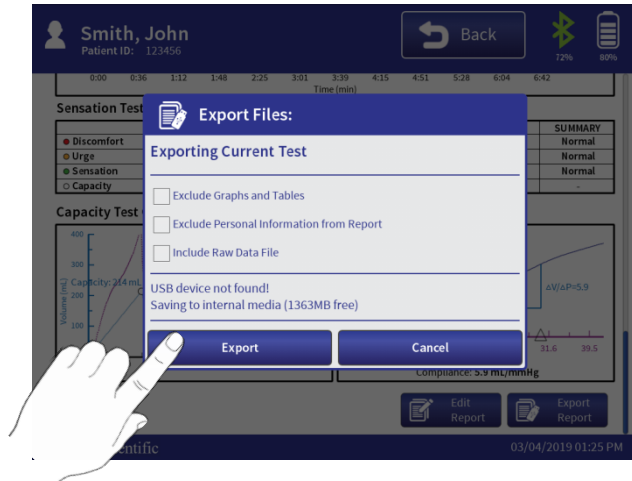

- 2) Once the report has been saved into the pump, connect a USB Mini cable to the USB Mini Connector on the left side of the pump. Then connect the other end of the cable to a computer.

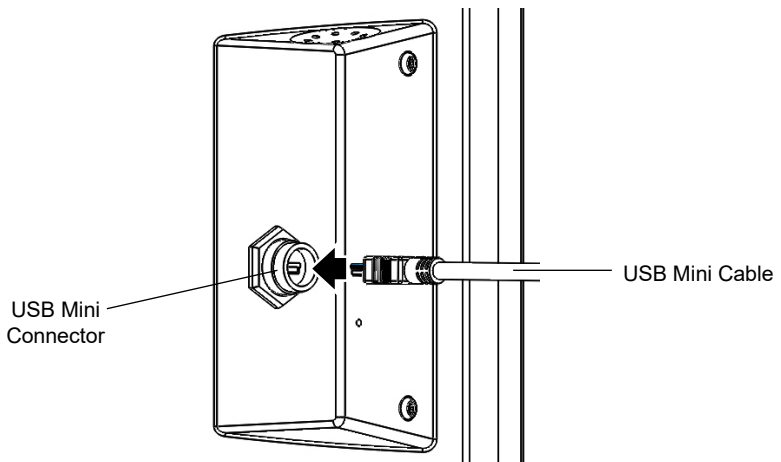

EXPORTING FILES

- 3) Once the pump is connected to a computer, the computer will recognize the pump as a USB device, AW-SoM A20. Users can navigate the internal folders of the pump on the computer.

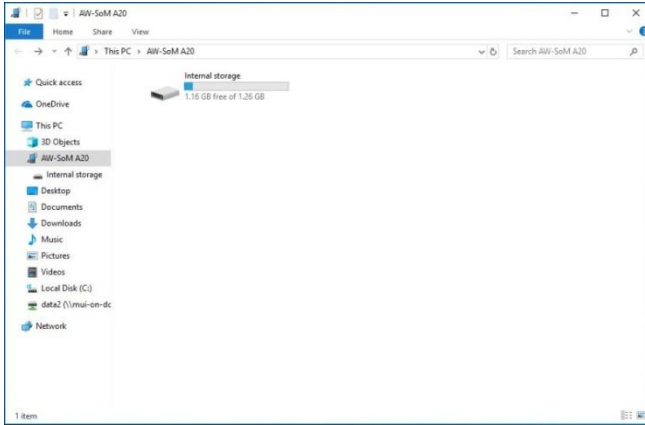

- 4) All patient test reports exported will be stored in a folder called **“MUI_EXPORTS”** under their respective patient name and ID. For our example, John Smith’s test report is stored in: ***AW-SoM A20\Internal Storage\MUI_EXPORTS\123456_Smith_John.***

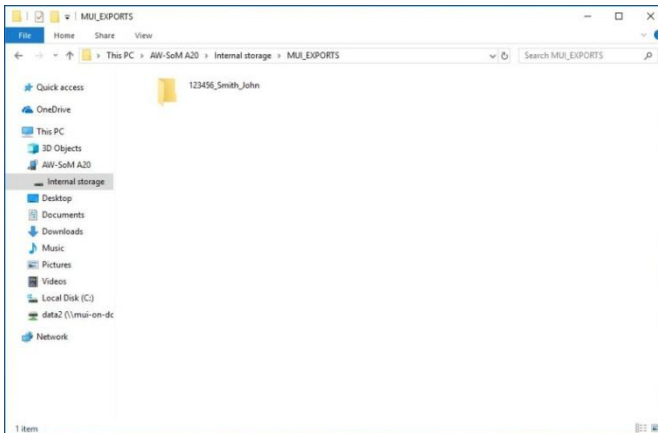

- 5) Users can copy the test report from the pump into their own computer. Ensure that the USB cable stays connected during the transfer.

EXPORTING FILES

Exporting a Multiple Test Reports:

- 1) Navigate to the patient's profile screen (John Smith in the example). Select **"File Options"** Button.

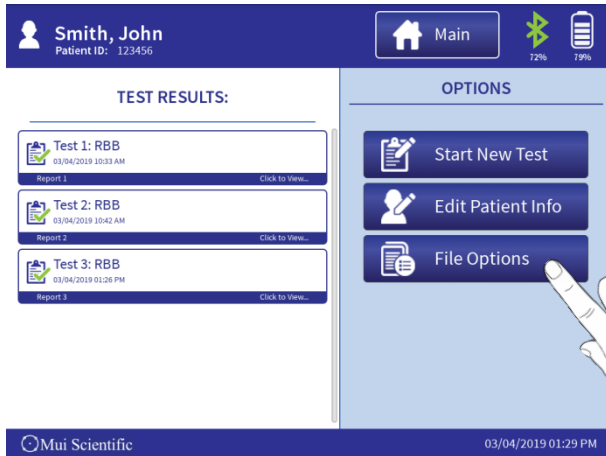

- 2) Select the desired test reports using the check box on the top right corner of each test. Subsequently, select **"Export Files"**.

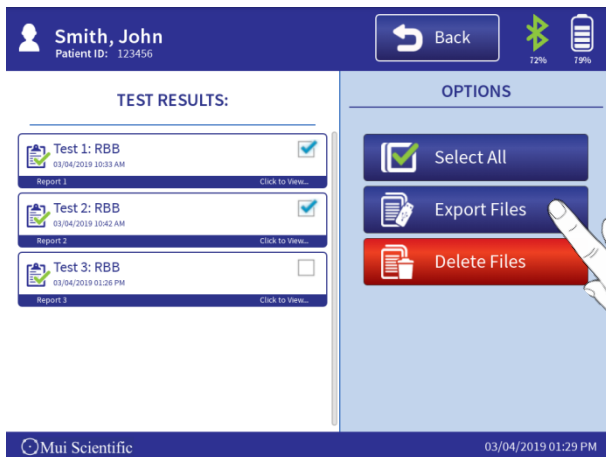

- 3) The export popup will appear. Choose any options as necessary and then select **"Export"** to export the reports.

EXPORTING FILES

Exporting Multiple Patients' Test Reports:

- 1) Navigate to the Patient Files Screen by selecting “**Patient Files**” in the Main Menu. Users can search, sort and filter the patients through the Options Panel.

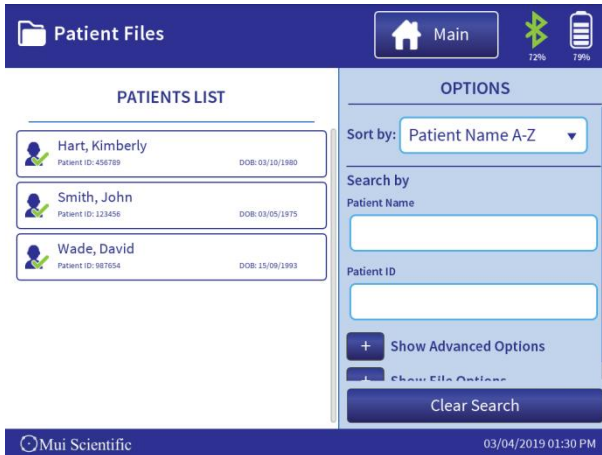

- 2) Scroll to the bottom of the Options Panel and select the “+” next to “**Show File Options**”. Select the desired patients, then select “**Export Files**”.

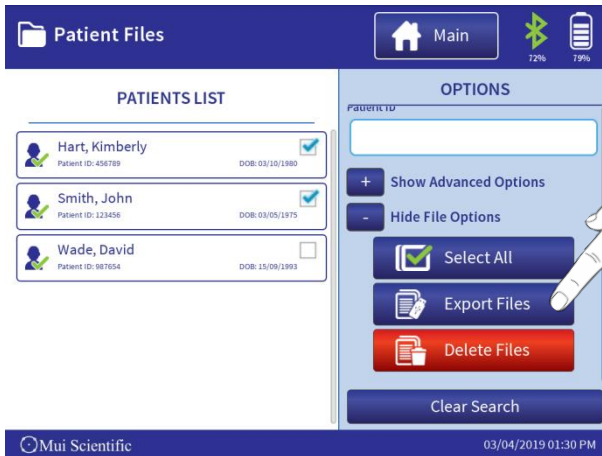

- 3) The export popup will appear. Choose any options as necessary and then select “**Export**” to export the reports.

TAKING SCREENSHOTS

Taking Screenshots:

- 1) Push and Hold the Power Button on the right side of the pump until a Power Off popup window appears on screen.

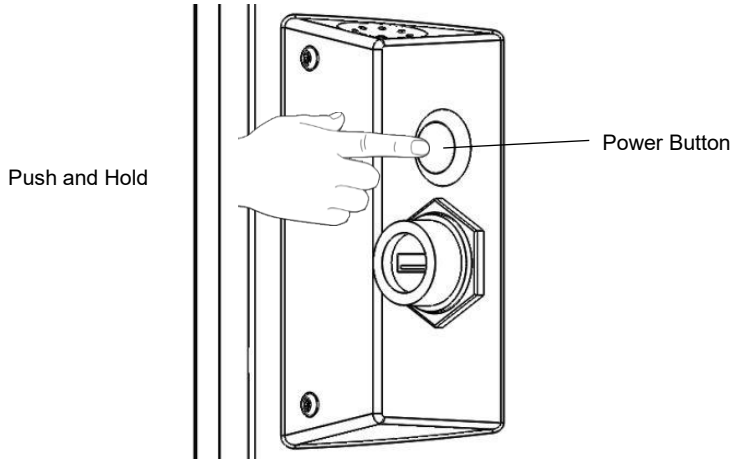

- 2) Select the “Take Screen Shot” button. A screenshot is taken in within a second, and it is then stored into the pump.

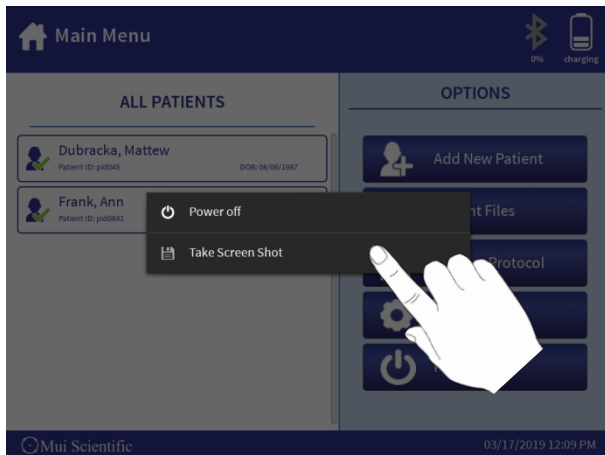

TAKING SCREENSHOTS

- 3) Plug the pump to a computer using a USB Mini Cable. The computer will detect the pump as a USB device and users can access the internal folders of the pump.

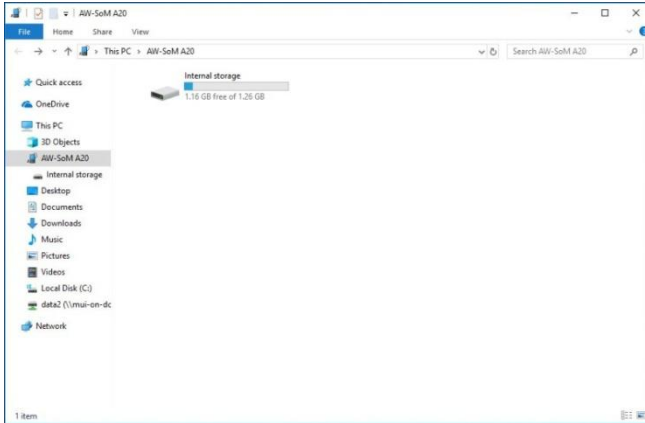

- 4) All screenshots taken are stored in a folder called "Screenshots". The location of the folder is is: AW-SoM A20\Internal storage\Pictures\Screenshots.

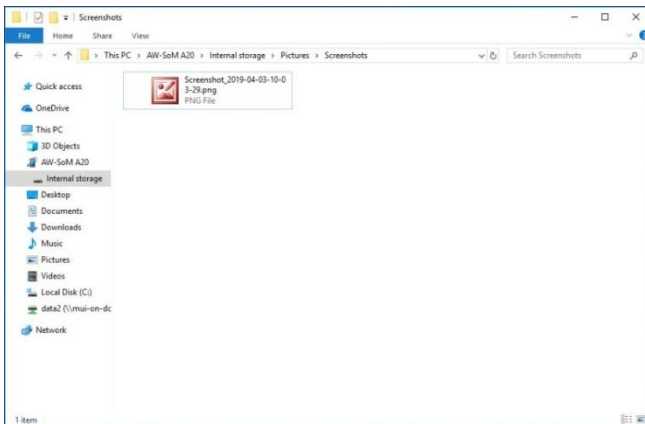

ERASING DATA AND RESTORING

The RBB Pump allows users to erase all existing data that is stored inside the pump. This data includes patient information, physician entries, test reports and raw data.

Deleting Entries in Dropdown Menus:

- 1) Select any Dropdown Menu field in the RBB Pump (below example shows “Operator” field). Push and hold the entry that is to be deleted, until a confirmation pop up screen appears.



- 2) Press “Yes” to delete the selected entry.



ERASING DATA AND RESTORING

Erasing Data in the RBB Pump:

- 1) Select the “**Settings**” from the Main Menu, and then select the “**System Options**” tab.

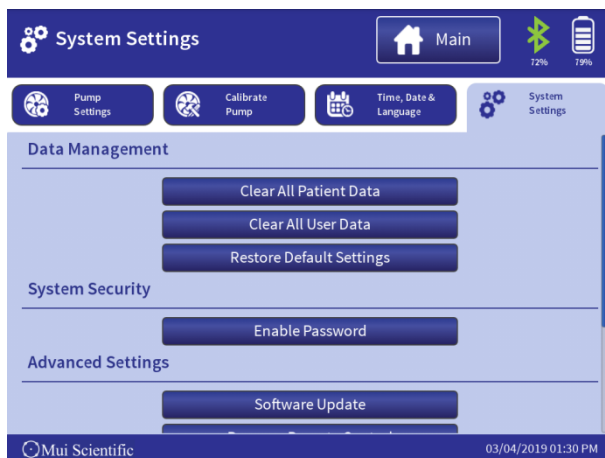

- 2) The users can then select from 2 different options:
 - Clear all Patient Data
 - *erase all patient information, test reports and raw data collected*
 - Clear All User Data
 - *erase all patient data and physician entries*

Restoring RBB Pump to Default Settings:

- 1) Select the “**Settings**” from the Main Menu, and then select the “**System Options**” tab.
- 2) Select the “**Restore Default Settings**” Button to reset all settings to default values.

RAPID BAROSTAT BAG PUMP

SERVICE & MAINTENANCE



CARE AND MAINTENANCE

The RBB Pump is a battery-operated touch screen portable device. Please follow these instructions to ensure the device's accuracy and longevity.

1. Do not subject the device to impacts or shocks, such as dropping the unit or storing it near strong vibrations.
2. Do not submerge the device or any of its components in water.
3. Maintain the unit regularly by wiping the surface of the touch screen with a dry microfiber cloth. **DO NOT USE ALCOHOL FOR CLEANING SCREEN.**
4. Use small amount of **70 % Alcohol** when cleaning the body of the unit and then leave the device to dry. Using a higher percentage alcohol may hasten the wear and tear of the device buttons.

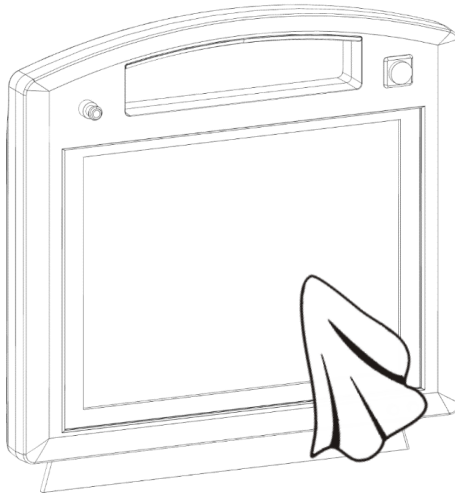

5. Charge the device overnight to ensure it is fully charged the next morning.
6. Keep the device in its carrying case for long-term storage.
7. Store the device and components in a dry, clean and safe location.
8. Only plug the device in standard power outlets.
9. Do not attempt to repair or disassemble the unit or components. Contact the manufacturer for assistance.

PUMP CALIBRATION

The RBB Pump uses highly sensitive airflow and pressure sensors that may degrade over time. This can cause inaccurate measurements by the pump. If users suspect the pump is not producing accurate results, they can perform a Volume Verification Test to determine if the pump's results are accurate. In addition, the Volume Verification Test should be performed every 3 months.

Pump Calibration:

- 1) All RBB Pumps are calibrated by the manufacturer before shipping. In addition, the RBB Pumps are programmed to automatically adjust their airflow to maintain the desired flow rate. However, extended use of the RBB Pump can reduce the pump's reaction time when adjusting their flow rate. Users are recommended to readjust the pump's reaction time before performing the Volume Verification Test.
- 2) In the Settings Screen, select the “**Calibrate Pump**” tab. Warning on the screen will appear. Select “**Dismiss**” button.

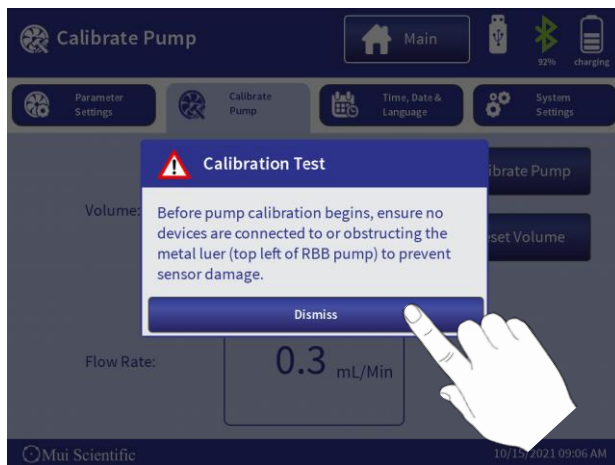

PUMP CALIBRATION

- 3) Select the “**Calibrate Pump**” button. This will automatically run the calibration program for the pump. The calibration will take **10 – 15 seconds** to complete.

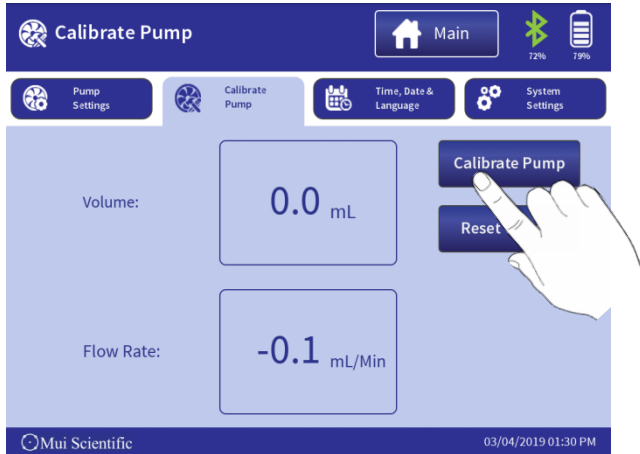

VOLUME VERIFICATION

Volume Verification Test:

- 1) To perform a Volume Verification Test, users will need to use the included Verification Bag. The Verification Bag has its capacity indicated on a label.

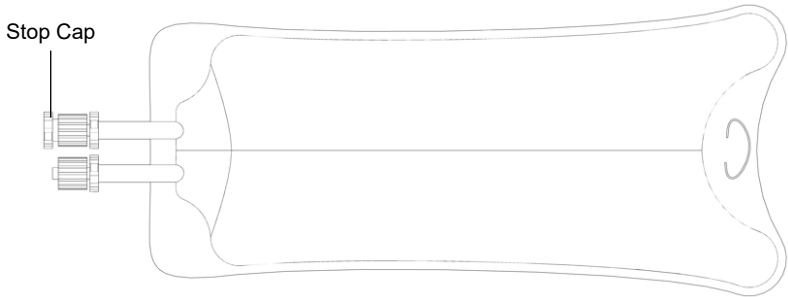

- 2) Attach the open port of the Verification Bag securely onto the RBB pump's Metal Luer. Ensure that the Stop Cap is installed securely on the other port.

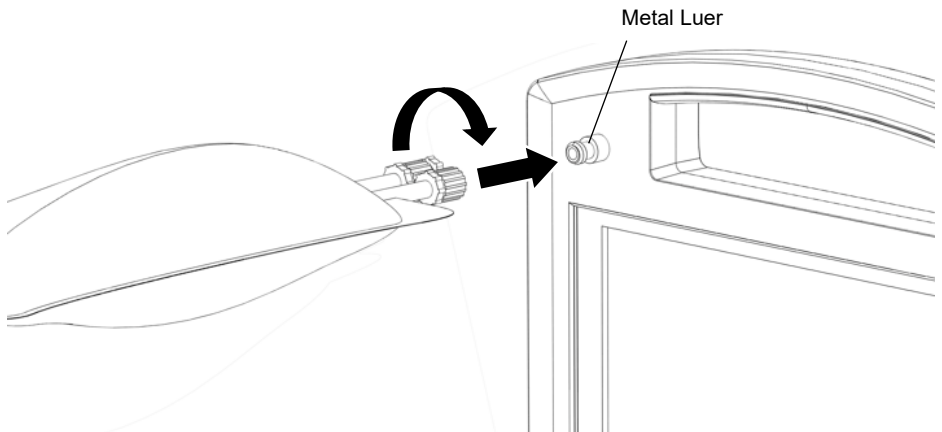

- 3) Navigate to Pump Settings Screen, select the “**Capacity Pressure Threshold**” to 60mmHg.

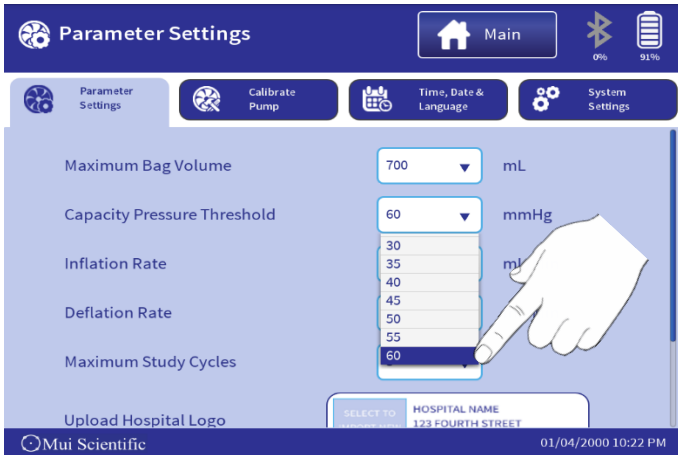

- 4) Press “**Save**” at the bottom of screen.

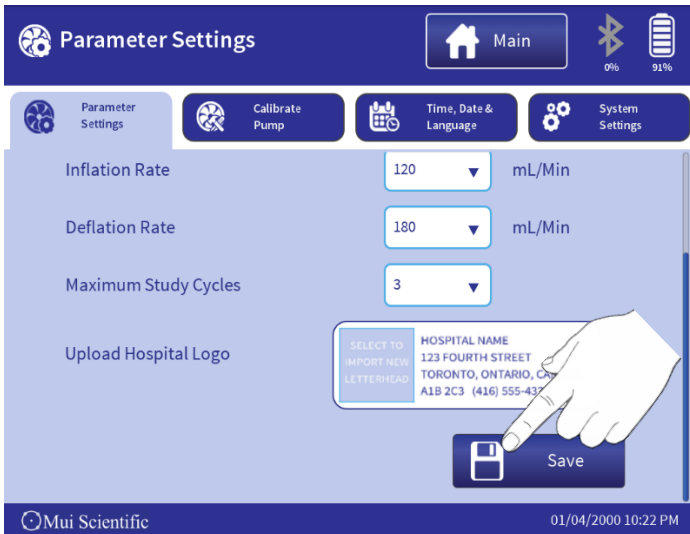

VOLUME VERIFICATION

- 5) Create a dummy patient for the Volume Verification Test. Navigate to the dummy patient's profile and select “**Start New Test**”. Ensure that all values are set to default (shown below), and then select “**Start Test**”.



- 6) Perform the usual steps taken to perform a RBB Test. The Volume Verification Test will only utilize the Capacity Test portion of the RBB Test. Allow the test to run regularly until the end of Capacity Test.

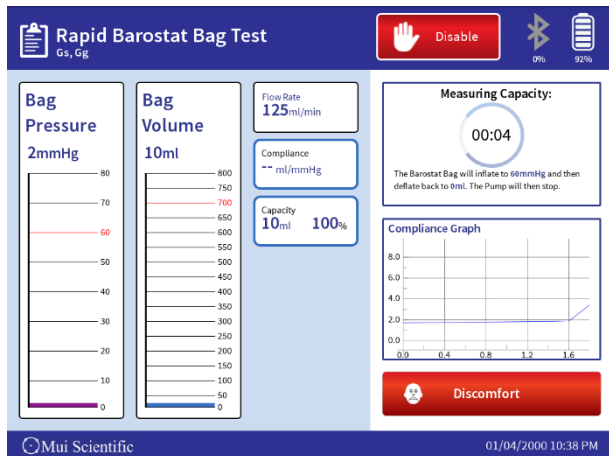

VOLUME VERIFICATION

- 7) Once Capacity Test is completed, compare the displayed capacity value on the RBB Pump to the capacity value indicated on the Verification Bag's label. If the capacity values are within $\pm 5\%$ of each other, then the pump is performing correctly.

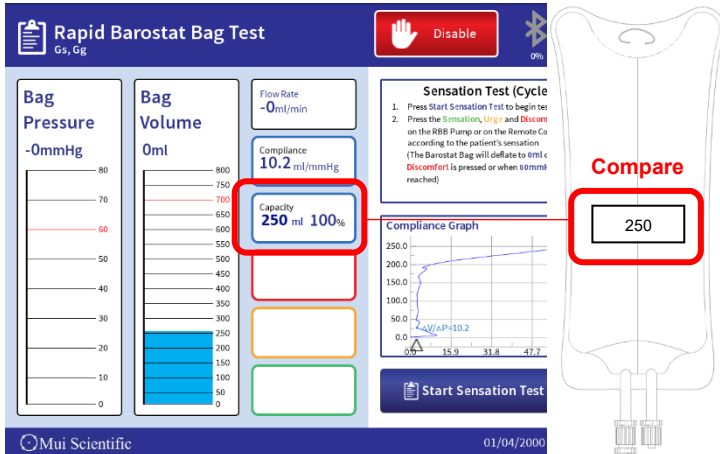

- 8) Performing multiple runs of the Volume Verification Test is recommended. If the comparison exceeds $\pm 5\%$ after multiple runs, please contact Mui Scientific for further support on the RBB Pump.

RESETTING PASSWORD

If users are unable to unlock the RBB Pump using their set password under any circumstances, they can select the “**Forgot password?**” option in the **Device Un-Lock** screen to recover access to their RBB Pump.

- 1) Select “**Forgot password?**” option in the **Device Un-Lock** screen.

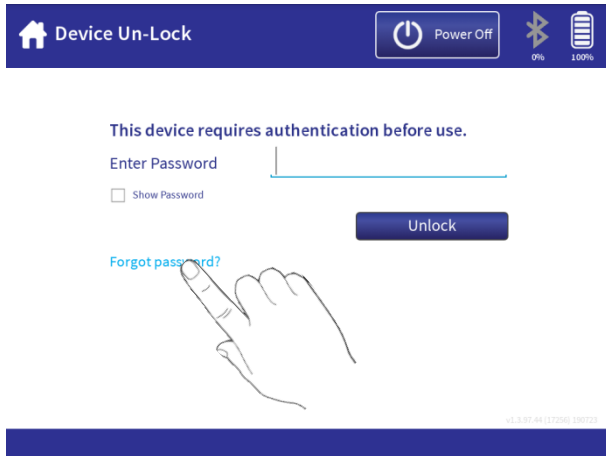

- 2) Contact Mui Scientific using the number shown on screen to begin the recovery process. Please provide Mui Scientific with the Unlock Code shown in the popup window during the recovery process.

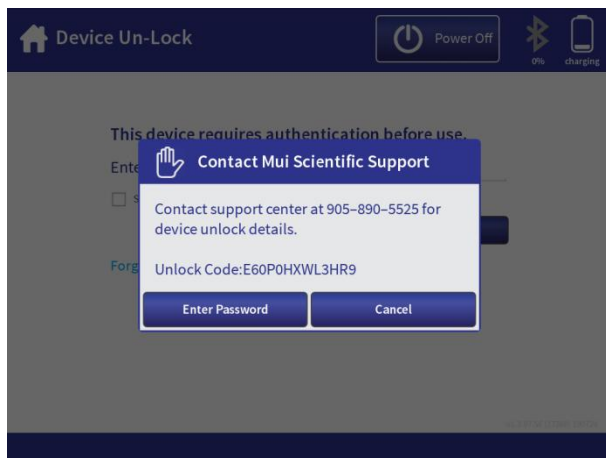

UPDATING SOFTWARE

Mui Scientific will occasionally release new software updates for the RBB Pump that will require installation by the users. These updates are highly recommended to be installed to the pumps as they often contain new features, upgrades and bug fixes for the RBB Pump. Users can also contact Mui Scientific for more information on the latest software version.

Updating RBB Pump Software:

- 1) A new software package is usually released directly from Mui Scientific as “.apk” file. Place the “.apk” file into an empty USB device, then plug that USB device into the USB Connector on the right side of the pump.

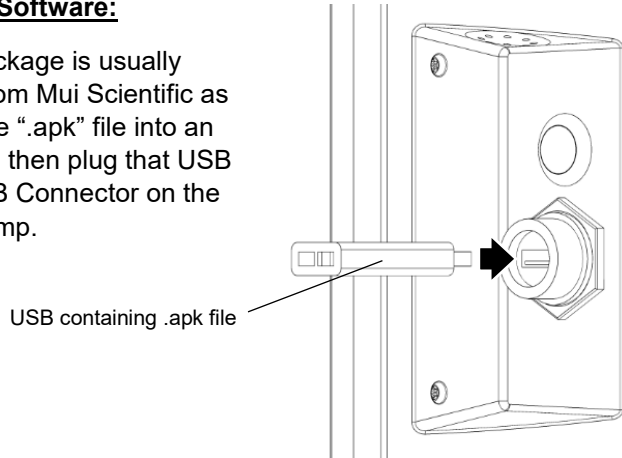

- 2) Navigate to Main Menu -> Settings -> System Settings. Select the “Software Update” button in the “Advanced Settings” category.

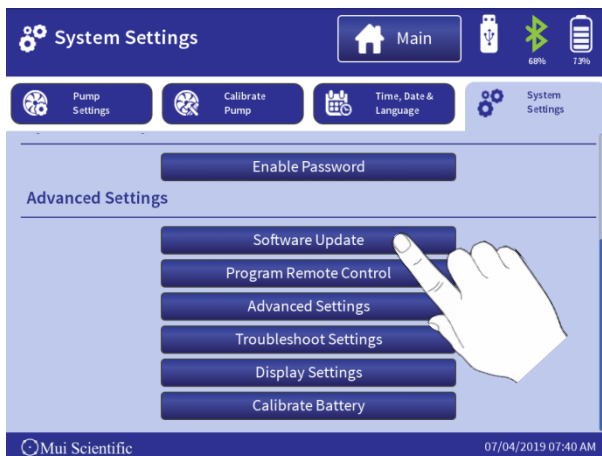

UPDATING SOFTWARE

- 3) Once the “Software Update” button has been selected, the RBB Pump will automatically detect the update file from the USB device and begin the updating process. A blue update background will appear on screen to display the update installation progress.

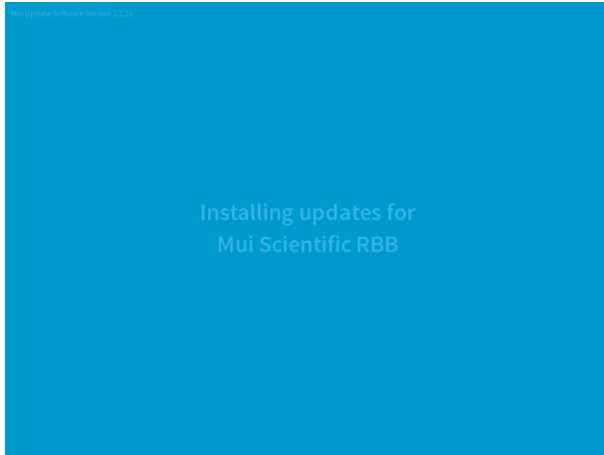

- 4) Once the update is complete, the update screen will show that all update tasks are completed. The pump will automatically restart and proceed back to the splash screen. The USB device can then be removed safely.

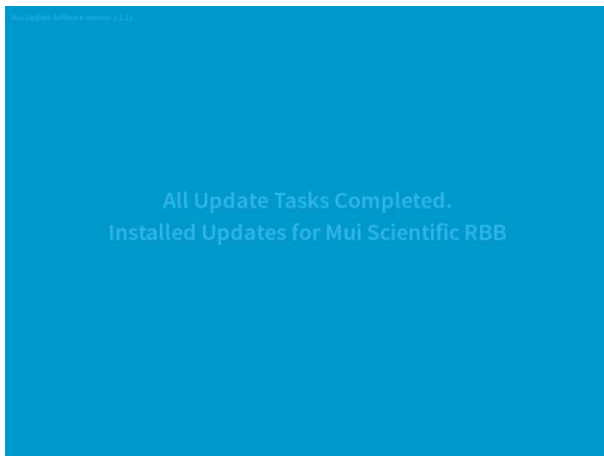

- 5) Contact Mui Scientific after successfully completing your update.

TROUBLESHOOTING

All troubleshooting activities to be conducted by pump operators can be accomplished via the touchscreen. There are NO user-serviceable parts within the pump, and therefore users should NOT attempt to disassemble the unit housing. If the pump requires servicing beyond the user capabilities, contact the manufacturer.

Barostat Bag will not inflate

- 1) Ensure the Disable Button on the pump is toggled to a DEPRESSED state (IN Position). The following warning will appear if the Disable Button is not toggled in during a test.



- 2) Check that the RBB Cather has been connected securely onto the RBB Pump's Metal Luer.

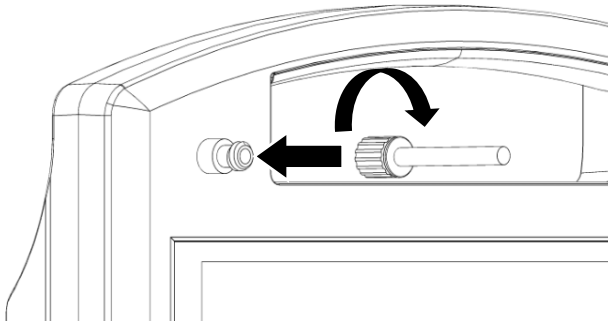

TROUBLESHOOTING

- 3) Check the seams of the catheter's bag and ensure that the bag is sealed shut at the seams.
- 4) If the bag does not inflate during an RBB test, ensure that the catheter has been inserted correctly into the patient's rectum, and that no bag is visible from the outside.
- 5) Perform the RBB test again by creating a new test on the patient. Verify if the bag will inflate properly in the new test.
- 6) Contact the manufacturer if none of the above is able to rectify the issue.

System Crashes

- 1) Ensure that the RBB test data has been saved successfully before exiting the test screen.
- 2) If the RBB Pump system crashes when opening a RBB test report, the following screen will appear.

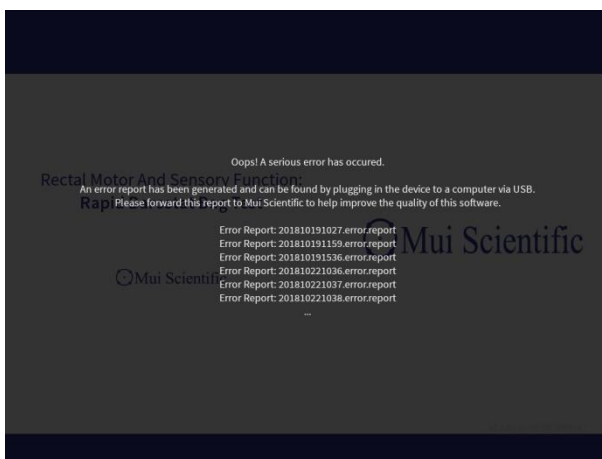

- 3) The above screen indicates that the data in the test report has been corrupted, likely due to invalid saving of data after the RBB Test.
- 4) Restart the pump and try to open the test report again.
- 5) Contact the manufacturer if restarting the pump is unable to prevent the crash in opening test report.

TROUBLESHOOTING

Errors in Volume and/or Pressure readings

1. The following warning screen will appear whenever an error has occurred in Volume and/or Pressure sensor.



2. Restarting the pump will automatically recalibrate the sensors.
3. Rerun any tests performed if the error occurred during a test.
4. Perform the Volume Verification Test to ensure that the sensors are operating optimally.
5. Contact the manufacturer if the warning appears persistently.

Constant screen flickering and/or pump is turning ON and OFF

- 1) In “Main Menu” select “Settings” than “System Settings – scroll down and select “Advance Settings”
- 2) Contact Mui Scientific for Admin Password and select “Submit”

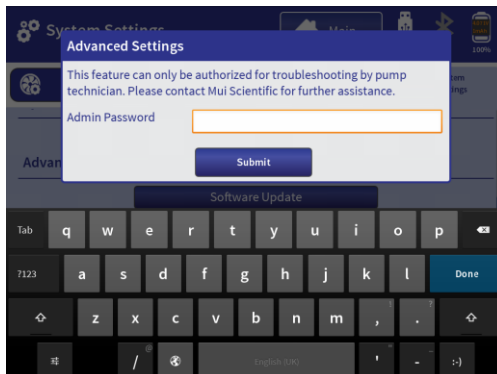

- 3) Select "Storage", select "Cache data", select "OK".
- 4) Contact Mui Scientific if the same problem occurs again.

REPLACEMENT PARTS

Description	Part #
Charging Dock	P5-RBB-B
RBB Remote Control and Base	P5-RBB-C
Power Adaptor	P5-D-113
Power Cord, Class II	P5-D-114
Demo Tube	P5-K-102
Verification Bag	P5-K-103
RBB Catheter	S7-BR-1018

THIS PAGE IS INTENTIONALLY LEFT BLANK

RAPID BAROSTAT BAG PUMP

APPENDICES



Appendix A

The RAPID BAROSTAT BAG (RBB) PUMP is intended for use in the electromagnetic environment specified below. The customer or the user of the RAPID BAROSTAT BAG (RBB) PUMP should assure that it is used in such an environment.		
Emissions Test	Compliance	Electromagnetic Environment – Guidance
RF Emissions CISPR 11	Group 1	The RAPID BAROSTAT BAG (RBB) PUMP uses RF energy only for its internal function. Therefore, its RF emissions are very low and are not likely to cause any interference in nearby electronic equipment.
RF Emissions CISPR 11	Class A	The RAPID BAROSTAT BAG (RBB) PUMP is suitable for use in all establishments other than domestic, and may be used in domestic establishments and those directly connected to the public low-voltage power supply network that supplies buildings used for domestic purposes, provided the following warning is heeded: Warning: This equipment/system is intended for use by healthcare professionals only. This equipment/system may cause radio interference or may disrupt the operation of nearby equipment. It may be necessary to take mitigation measures, such as re-orienting or relocating the RAPID BAROSTAT BAG (RBB) PUMP or shielding the location.
Harmonic Emissions IEC 61000-3-2	Class A	
Voltage Fluctuations/ Flicker Emissions IEC 61000-3-3	Complies	

Appendix B

The RAPID BAROSTAT BAG (RBB) PUMP is intended for use in the electromagnetic environment specified below. The customer or the user of the RAPID BAROSTAT BAG (RBB) PUMP should assure that it is used in such an environment.			
Immunity Test	IEC 60601 Test Level	Compliance Level	Electromagnetic Environment – Guidance
Electrostatic Discharge (ESD) IEC 61000-4-2	±6 kV Contact ±8 kV Air	±6 kV Contact ±8 kV Air	Floors should be wood, concrete or ceramic tile. If floors are covered with synthetic material, the relative humidity should be at least 30%.
Electrical Fast Transient/Burst IEC 61000-4-4	±2 kV for power supply lines	±2 kV for power supply lines	Mains power quality should be that of a typical commercial or hospital environment.
Surge IEC 61000-4-5	±1 kV line(s) to line(s) ±2 kV line(s) to earth	±1 kV line(s) to line(s) ±2 kV line(s) to earth	Mains power quality should be that of a typical commercial or hospital environment.
Voltage Dips, short interruptions and voltage variations on power supply input lines IEC 61000-4-11	<5% U_T (>95 % dip in U_T) for 0,5 cycle 40% U_T (60% dip in U_T) for 5 cycles 70% U_T (30% dip in U_T) for 25 cycles <5% U_T (>95% dip in U_T) for 5 sec	<5% U_T (>95 % dip in U_T) for 0,5 cycle 40% U_T (60% dip in U_T) for 5 cycles 70% U_T (30% dip in U_T) for 25 cycles <5% U_T (>95% dip in U_T) for 5 sec	Mains power quality should be that of a typical commercial or hospital environment. If the user of the RAPID BAROSTAT BAG (RBB) PUMP requires continued operation during power mains interruptions, it is recommended that the RAPID BAROSTAT BAG (RBB) PUMP be powered from an uninterruptible power supply or a battery.
Power Frequency Magnetic Field (50/60 Hz) IEC 61000-4-8	3 A/m	3 A/m	Power frequency magnetic fields should be at levels characteristic of a typical location in a typical commercial or hospital environment.
NOTE U_T is the a.c. mains voltage prior to application of the test level.			

Appendix C

The RAPID BAROSTAT BAG (RBB) PUMP is intended for use in the electromagnetic environment specified below. The customer or the user of the RAPID BAROSTAT BAG (RBB) PUMP should assure that it is used in such an environment.			
Immunity Test	IEC 60601 Test Level	Compliance Level	Electromagnetic Environment – Guidance
<p>Conducted RF IEC 61000-4-6</p>	<p>3 Vrms 150 kHz to 80 MHz</p>	<p>3 Vrms</p>	<p>Portable and mobile RF communications equipment should be used no closer to any part of the RAPID BAROSTAT BAG (RBB) PUMP including cables, than the recommended separation distance calculated from the equation applicable to the frequency of the transmitter.</p> <p>Recommended separation distance</p> $d = 1.2\sqrt{P}$
<p>Radiated RF IEC 61000-4-3</p>	<p>3 V/m 80 MHz to 2,5 GHz</p>	<p>3 V/m</p>	<p>$d = 1.2\sqrt{P}$ 80 MHz to 800 MHz</p> <p>$d = 2.3\sqrt{P}$ 800 MHz to 2.5 GHz</p> <p>where P is the maximum output power rating of the transmitter in watts (W) according to the transmitter manufacturer and d is the recommended separation distance in metres (m).</p> <p>Field strengths from fixed RF transmitters, as determined by an electromagnetic site survey^a should be less than the compliance level in each frequency range^b</p> <p>Interference may occur in the vicinity of known RF transmitting devices and equipment marked with the following symbol:</p> <div style="text-align: center;">  </div>
<p>NOTE 1 At 80 MHz and 800 MHz, the higher frequency range applies.</p>			
<p>NOTE 2 These guidelines may not apply in all situations. Electromagnetic propagation is affected by absorption and reflection from structures, objects and people.</p>			
<p>a) Field strengths from fixed transmitters, such as base stations for radio (cellular/cordless) telephones and land mobile radios, amateur radio, AM and FM radio broadcast and TV broadcast cannot be predicted theoretically with accuracy. To assess the electromagnetic environment due to fixed RF transmitters, an electromagnetic site survey should be considered. If the measured field strength in the location in which the RAPID BAROSTAT BAG (RBB) PUMP is used exceeds the applicable RF compliance level above, the RAPID BAROSTAT BAG (RBB) PUMP should be observed to verify normal operation. If abnormal performance is observed, additional measures may be necessary, such as re-orienting or relocating the RAPID BAROSTAT BAG (RBB) PUMP</p>			
<p>b) Over the frequency range 150 kHz to 80 MHz, field strengths should be less than 3 V/m.</p>			

Appendix D

Recommended separation distances between portable and mobile RF communications equipment and the RAPID BAROSTAT BAG (RBB) PUMP			
<p>The RAPID BAROSTAT BAG (RBB) PUMP is intended for use in an electromagnetic environment in which radiated RF disturbances are controlled. The customer or the user of the RAPID BAROSTAT BAG (RBB) PUMP can help prevent electromagnetic interference by maintaining a minimum distance between portable and mobile RF communications equipment (transmitters) and the RAPID BAROSTAT BAG (RBB) PUMP as recommended below, according to the maximum output power of the communications equipment.</p>			
Rated maximum output power of transmitter W	Separation distance according to frequency of transmitter m		
	150 kHz to 80 MHz $d = 1.2\sqrt{P}$	80 MHz to 800 MHz $d = 1.2\sqrt{P}$	800 MHz to 2.5 GHz $d = 2.3\sqrt{P}$
0.01	0.12	0.12	0.24
0.1	0.38	0.38	0.73
1	1.2	1.2	2.3
10	3.8	3.8	7.3
100	12	12	23
<p>For transmitters rated at a maximum output power not listed above, the recommended separation distance d in metres (m) can be estimated using the equation applicable to the frequency of the transmitter, where P is the maximum output power rating of the transmitter in watts (W) according to the transmitter manufacturer.</p> <p>NOTE 1 At 80 MHz and 800 MHz, the separation distance for the higher frequency range applies.</p> <p>NOTE 2 These guidelines may not apply in all situations. Electromagnetic propagation is affected by absorption and reflection from structures, objects and people.</p>			

THIS PAGE IS INTENTIONALLY LEFT BLANK.